



DIMCAR
CityLifeDesign

DIMCAR_CATALOGUE



DIMCAR.IT

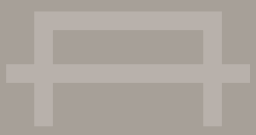

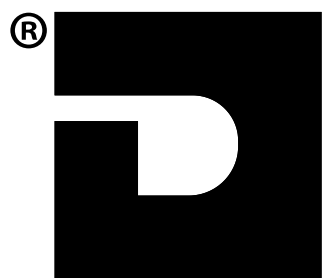

DIMCAR
CityLifeDesign



Cos'è quella forza che spinge un imprenditore ad affrontare sfide e difficoltà ogni giorno e riempirsi d'impegni trascurando affetti e vita privata?

Me lo chiedo spesso nel cuore della notte, quando resto solo coi miei pensieri.

La risposta che mi do è: **fare un buon lavoro.**

È la soddisfazione di spegnere le luci la sera con l'orgoglio d'aver portato la nave in porto dopo un altro viaggio intenso e bellissimo. La consapevolezza di aver trasmesso una **visione** e un obiettivo a chi ha remato con me. Non solo per noi stessi ma **per lasciare qualcosa di significativo agli altri.**

Per questo, quello che hai tra le mani non è solo un catalogo. **Stai per sfogliare la nostra idea di città.** Di spazi pensati per migliorare la vita di tutti i giorni.

Ogni soluzione d'arredo urbano che troverai è stata creata con l'ambizione di portare **qualcosa di bello e di concreto** per le persone.

Sfoglialo con calma, come si osserva un panorama. Trova ispirazione, immagina nuove possibilità e scopri la bellezza di ciò che possiamo costruire insieme.

What is that force that drives an entrepreneur to face challenges and difficulties every day, filling their schedule while neglecting relationships and personal life?

I often ask myself this in the middle of the night when I'm left alone with my thoughts.

*The answer I give myself is: **to do a good job.***

*It's the satisfaction of turning off the lights at night with the pride of having brought the ship to port after another intense and beautiful journey. The awareness of having conveyed a **vision** and a goal to those who rowed with me. Not just for ourselves but to **leave something meaningful to others.***

*That's why what you hold in your hands is not just a catalog. **You are about to leaf through our vision of the city.** Of spaces designed to improve everyday life.*

*Every urban furniture solution you'll find was created with the ambition of bringing **something beautiful and tangible** to people.*

Leaf through it slowly, as you would admire a landscape. Find inspiration, imagine new possibilities, and discover the beauty of what we can build together.

Lorenzo Dima



**IL GRUPPO,
LA NOSTRA
FORZA**

**THE GROUP,
OUR STRENGTH**

I NUMERI CHE RACCONTANO LA NOSTRA LEADERSHIP

THE NUMBERS THAT TELL OUR LEADERSHIP STORY



Trend di crescita ultimi 5 anni
Growth trend over the last 5 years

+56,35%



Spazi produttivi
Production spaces

17.000 m²

OPIFICI + UFFICI 2024



Clienti attivi
Active clients

1500



Ferro utilizzato
Material used

7.000

tonnellate / tons



Comuni serviti
Municipalities served

4.016



Numero dipendenti e collaboratori
Number of employees and collaborators

66

2023



Prodotti a catalogo
Products in the catalog

500



Tempo medio per la consegna
Average delivery time

15-20 gg



OUR CERTIFICATIONS

Da anni, Dimcar si dedica con passione e rigore alla realizzazione di elementi d'arredo urbano che rispecchiano l'eccellenza italiana.

Questa dedizione è confermata e riconosciuta dalle nostre numerose certificazioni di qualità.

Ogni pezzo che portiamo nel tessuto urbano è un segno tangibile del nostro impegno a rispettare gli standard più alti dell'industria.

For years, Dimcar has passionately and meticulously crafted urban furniture that embodies Italian excellence.

This dedication is affirmed and recognized through our numerous quality certifications.

Every piece we introduce to urban spaces is a tangible testament to our commitment to upholding the highest industry standards.



INSIEME PER MIGLIORARE GLI SPAZI URBANI.

WORKING TOGETHER TO MAKE URBAN SPACES BETTER

Progettare spazi urbani per noi significa pensare alle persone. Ogni cittadino, indipendentemente dall'età, dalle capacità o dalle esigenze, deve sentirsi accolto in un ambiente sicuro, confortevole e accessibile. Non si tratta solo di estetica: è funzionalità, inclusione, socialità. Creiamo aree in cui ogni dettaglio parla di ergonomia per chi ha mobilità ridotta, di praticità per le famiglie, di luoghi pensati per incontrarsi e vivere insieme. Ogni nostro prodotto – dalle panchine alle pensiline, dai cestini ai complementi – è progettato per durare, rispettare l'ambiente e migliorare il contesto urbano. Non lasciamo nulla al caso: il design degli spazi pubblici, per noi, un atto di cura verso la comunità.

Creating urban spaces for us involves considering people.

Regardless of age, ability, or needs, all citizens should feel welcomed in a safe, comfortable, and accessible environment.

It's not just about aesthetics: it's about functionality, inclusivity, and sociability.

Our spaces are designed with ergonomics in mind for individuals with disabilities, family convenience, and a sense of community. Our products, whether they're benches, bus shelters, litter bins, or accessories, are designed to last, respect the environment, and enhance the urban environment.

The design of public spaces is a reflection of our care for the community and we do not leave anything to chance.



**PROMUOVI
L'INCLUSIVITÀ
CON LE NOSTRE
NUOVE LINEE
DI ARREDO URBANO**

**PROMOTE INCLUSIVITY
WITH OUR NEW URBAN
FURNITURE LINES**

NOI

IO

Le due nuove linee IO e NOI, partono dalla necessità di socializzazione che ha l'individuo per ripensare l'ambiente urbano con un nuovo approccio, basato su sostenibilità, inclusività e connessione, tra persone e tra cose.

The two new lines, IO and NOI, stem from the individual's need for socialization to rethink the urban environment with a new approach based on sustainability, inclusivity, and connection—between people and things.





B2B

In DIMCAR, la soddisfazione del cliente è al centro del nostro impegno. Per questo motivo, abbiamo sviluppato una solida politica di assistenza pre e post vendita, che garantisce un supporto continuo e personalizzato in ogni fase del processo di acquisto, dalla consulenza iniziale fino all'assistenza dopo la consegna del prodotto.

At DIMCAR, customer satisfaction is at the heart of our commitment. For this reason, we have developed a robust pre- and post-sales support policy, ensuring continuous and personalized assistance at every stage of the purchasing process, from the initial consultation to after-sales support.

Our goal is to provide customers with a seamless and comprehensive experience, helping them find the best solutions for their needs and guiding them with professionalism and expertise at every step.

Il nostro obiettivo è fornire ai clienti un'esperienza completa e senza problemi, aiutandoli a trovare le soluzioni migliori per le loro esigenze e accompagnandoli con professionalità e competenza in ogni fase.

CONSULENZA PRE- VENDITA PER EFFICIENTARE IL TUO LAVORO

Consulenza personalizzata:

Il nostro team collabora con il cliente, tenendo conto di funzionalità, estetica e budget per ottimizzare la scelta.

Progettazione su misura:

Possiamo personalizzare i prodotti o sviluppare soluzioni nuove secondo le specifiche del cliente.

Preventivi trasparenti:

Forniamo preventivi chiari e senza costi nascosti, sempre disponibili per chiarimenti.

Assistenza tecnica:

Supportiamo progetti complessi con consulenze su materiali, sicurezza e installazione.

PRE-SALES CONSULTATION TO IMPROVE THE EFFICIENCY OF YOUR WORK

Personalized Consultation:

Our team collaborates with clients, considering functionality, aesthetics, and budget to optimize their choices.

Custom Design:

We can customize products or develop new solutions based on the client's specifications.

Transparent Quotes:

We provide clear, upfront quotes with no hidden costs and are always available for clarifications.

Technical Support:

We assist with complex projects by offering advice on materials, safety, and installation.



ASSISTENZA POST- VENDITA CON SERVIZIO CLIENTI DEDICATO

Installazione:

Forniamo supporto con istruzioni dettagliate e tecnici specializzati.

Garanzia:

I nostri prodotti sono coperti da garanzia per difetti, con interventi rapidi per riparazioni o sostituzioni.

Supporto:

Il nostro team è disponibile per assistenza veloce via telefono ed email.

AFTER-SALES ASSISTANCE WITH DEDICATED CUSTOMER SERVICE

Installation:

We provide support with detailed instructions and specialized technicians.

Warranty:

Our products are covered by a warranty for defects, with prompt repair or replacement services.

Support:

Our team is available for quick assistance via phone and email.



100%
CLIENTI
SODDISFATTI

100% satisfied customers

Francesco

★★★★★

Prodotti di alta
manifattura, massima
disponibilità, cordiali e
disponibili!

*High-quality
craftsmanship, utmost
availability, friendly and
helpful!*

Diego

★★★★★

Ottimi prodotti
e ottimo servizio

*Excellent products
and excellent service.*

Roberto

★★★★★

Panchine
comodissime

*Very comfortable
benches.*

Francesca

★★★★★

Sono molto belle
le vostre pensiline!
Finalmente qualcosa di
bello ed elegante a
Reggio Calabria

*Your canopies are
beautiful!
Finally, something both
beautiful and elegant in
Reggio Calabria.*



CONTENT

16
LINEA IO
LINEA IO

34
LINEA NOI
LINEA NOI

50
LINEA KOMETE
LINEA KOMETE

64
LINEA PINCH
LINEA PINCH

76
LINEA URBAN BABY
LINEA URBAN BABY

110
PENSILINE, CICLOSTAZIONI
E COPERTURE
BUS SHELTERS, BIKE STATIONS
AND CANOPIES

136
RASTRELLIERE PORTABICI
BIKE RACKS

156
PANCHINE E PANCHE
DA ESTERNO
OUTDOOR BENCHES
AND SEATING

192
CESTINI E CESTONI
PORTARIFIUTI DA ESTERNO
OUTDOOR LITTER BINS

220
CESTINI E CESTONI RACCOLTA
DIFFERENZIATA
OUTDOOR RECYCLING LITTER BINS

260
FIORIERE
PLANTERS

292
PARAPEDONI
CITY BARRIERS

336
INDICI GENERALI
GENERAL INDEXS

238
POSACENERE
OUTDOOR ASHTRAYS

276
GRIGLIE E SALVAPIANTE
TREE GRIDS AND GUARDS

318
SUPPORTI
INFORMATIVI
OUTDOOR NOTICE BOARDS

412
APPENDICE
COLORI E MATERIALI
COLORS AND MATERIALS

248
TAVOLI DA PICNIC
PICNIC TABLES

306
DISSUASORI
BOLLARDS

330
FONTANE
DRINKING FOUNTAINS

lo è una linea di arredo urbano che offre una profonda libertà compositiva: consente di combinare insieme i suoi moduli o tenerli separati, aiuta a delimitare lo spazio, creare percorsi, disegnarne le geometrie, offrendo a chi vive la città l'opportunità di stare insieme agli altri o ritagliarsi piccoli momenti per sé, pur rimanendo in città.

lo is a collection of urban furniture that allows for a great deal of flexibility in composition: Its modules can be combined or kept separate, and it assists in delimiting the space, creating paths, and drawing its geometries, giving city dwellers the chance to socialize or create intimate moments for themselves while staying in the city.

linea



SCEGLI ARREDI URBANI
CHE METTONO AL CENTRO
L'INDIVIDUO E LA SUA
ESPERIENZA.



*CHOOSE URBAN FURNITURE THAT
PUTS THE INDIVIDUAL AND THEIR
EXPERIENCE AT THE CENTER.*



DIMCAR
CityLifeDesign





INDEX LINEA



604-PE-2-COMP1
pag. 22



604-PE-3-COMP1
pag. 24



604-PE-4-COMP1
pag. 26



604-PE-O-V
optional parete laterale vetrata /
optional glazed side wall



604-PE-O-T
optional tavolino /
optional table



604-SOL
pag. 31

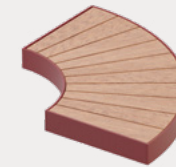

604-EL-C
elemento di collegamento curvo /
curved connecting element



604-EL-Q
elemento di collegamento quadrato /
square connecting element



604-PE-O-PC
pag. 31



604-PE-O-PL
pag. 31



604-PA
pag. 31



604-FIO-135
pag. 32



604-FIO-110
pag. 32



604-FIO-090
pag. 32



604-CO-L
pag. 33



604-CO-M
pag. 33



IO

604-PE-2-COMP1
PENSILINA 2 MODULI /
SHELTER 2 MODULES

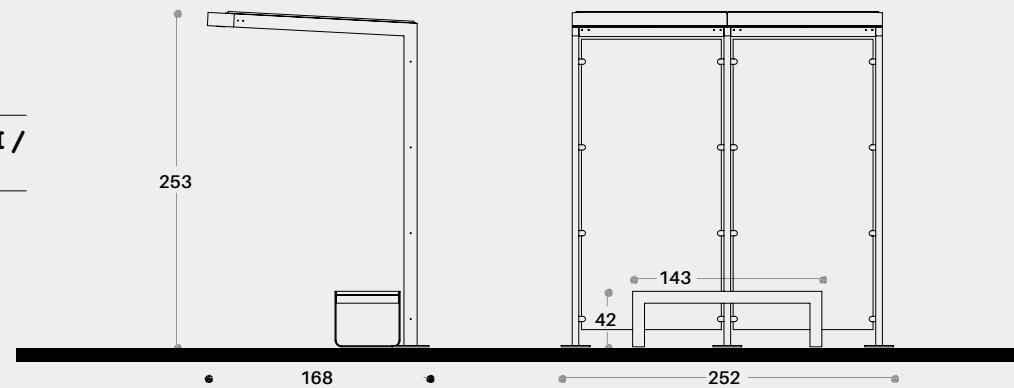

Designer	Dimcar Design Department
Dimensioni / Sizes	252x168 cm H 253 cm - 368 kg
Materiali / Materials	Acciaio zincato, Listoni in legno, Vetro stratificato / Galvanized steel, Wooden planks, Laminated glass
Fissaggio / Fixing	Predisposizione per zanche / By means of metal clamps
Optionals / Optionals	Parete laterale vetrata / Glass side wall
Plus / Plus	Illuminazione, panca corta / Lighting, short seat





IO

604-PE-3-COMP1
PENSILINA 3 MODULI /
SHELTER 3 MODULES

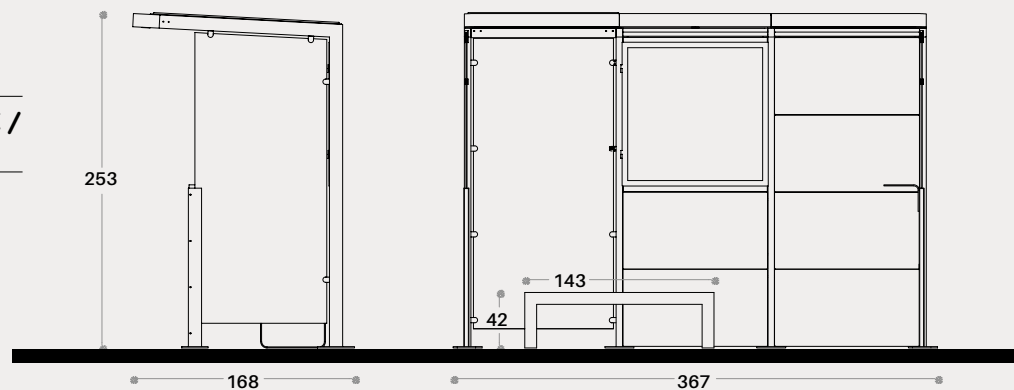

Designer	Dimcar Design Department
Dimensioni / Sizes	367x168 cm H 253 cm - 609 kg
Materiali / Materials	Acciaio zincato, Listoni in legno, Vetro stratificato / Galvanized steel, Wooden planks, Laminated glass
Fissaggio / Fixing	Predisposizione per zanche / By means of metal clamps
Plus / Plus	Illuminazione, Pareti laterali in vetro, Modulo bacheca, Modulo in lamiera, Tavolino, Panca corta / Lighting, Glass side walls, Bulletin board module, Sheet metal module, Small table, Short seat





IO

604-PE-4-COMP1
PENSILINA 4 MODULI /
SHELTER 4 MODULES

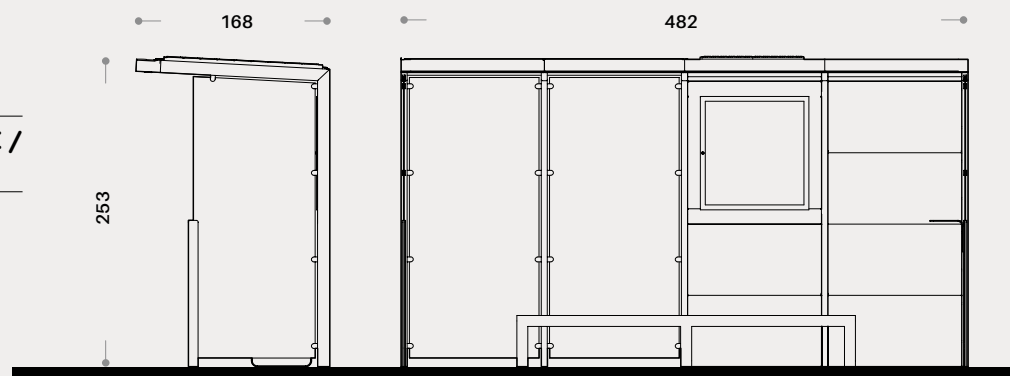

Designer	Dimcar Design Department
Dimensioni / Sizes	482x168 cm H 253 cm - 731 kg
Materiali / Materials	Acciaio zincato, Listoni in legno, Vetro stratificato / Galvanized steel, Wooden planks, Laminated glass
Fissaggio / Fixing	Predisposizione per zanche / By means of metal clamps
Plus / Plus	Illuminazione, Paredi laterali in vetro, Modulo bacheca, Modulo in lamiera, Tavolino, Panca lunga / Lighting, Glass side walls, Bulletin board module, Sheet metal module, Small table, Large seat



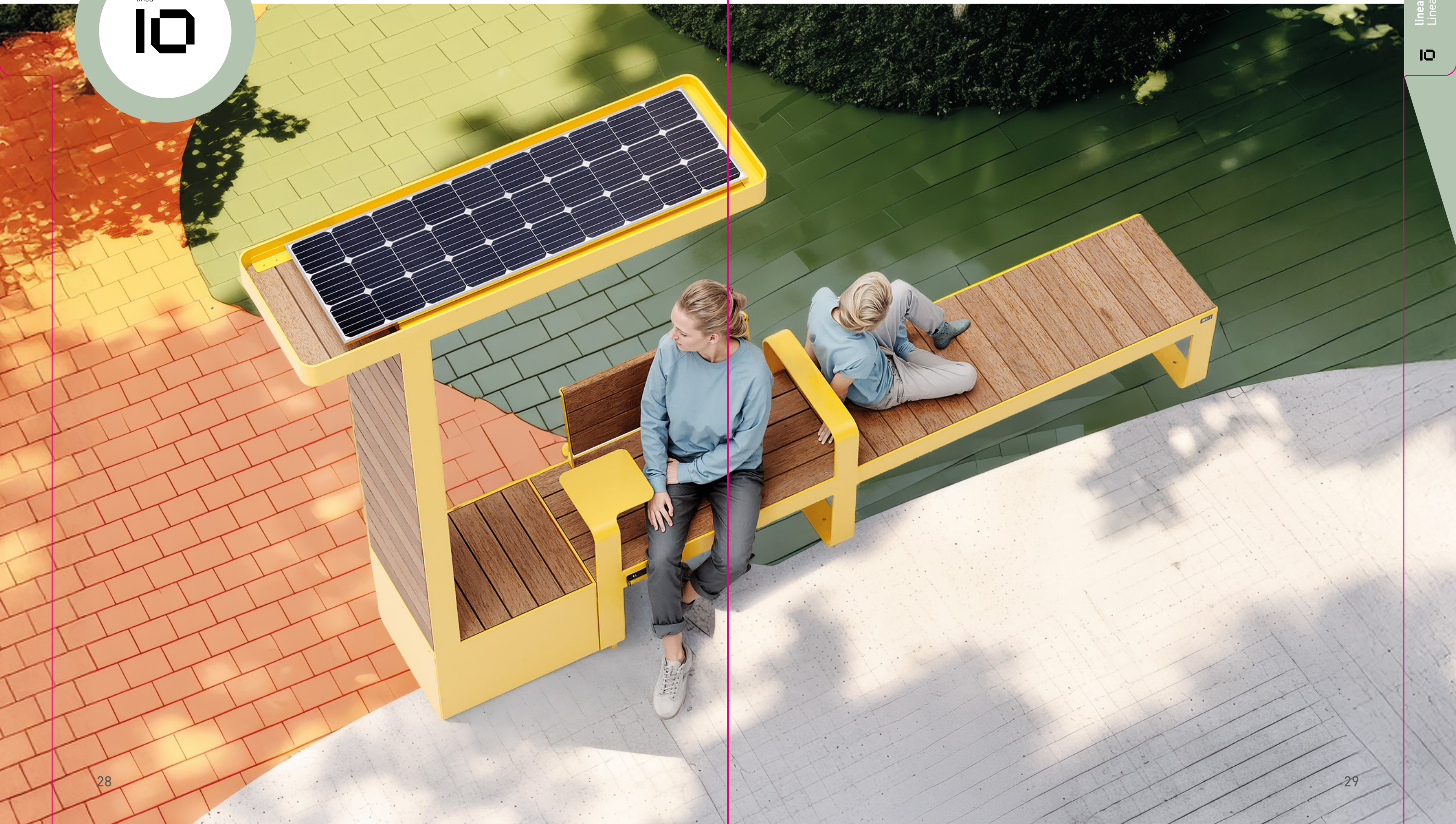



prodotti modulabili

Telaio composto da supporti sagomati in lamiera zincata ricavati da taglio laser con angoli sagomati, e dotati alla base di fori per l'ancoraggio al suolo; bracciolo intermedio sagomato e tavolino laterale, realizzati in lamiera zincata. Rivestimento seduta e schienale realizzato in profili di legno tipo okumè.

modular products

The frame consists of shaped galvanized sheet metal supports, laser-cut with shaped corners, and equipped at the base with holes for ground anchoring; an intermediate shaped armrest and a side table, both made of galvanized sheet metal. Seat and backrest cladding made of okumè wood profiles.

Designer	Dimcar Design Department
Materiali / Materials	Acciaio zincato, Listoni in legno / Galvanized steel, Wooden planks
Fissaggio / Fixing	Predisposizione per tasselli / Predisposition for dowels



604-PE-0-PC
OPTIONAL PANCHINA CORTA /
OPTIONAL SHORT SEAT

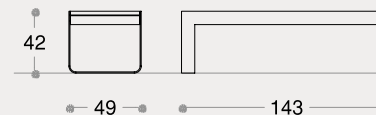

604-PE-0-PL
OPTIONAL PANCHINA LUNGA /
OPTIONAL LARGE SEAT

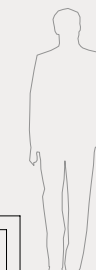
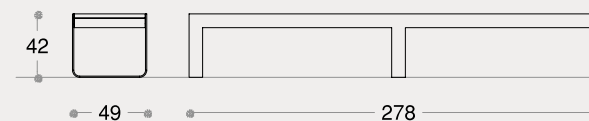

604-PA
PANCA / BENCH

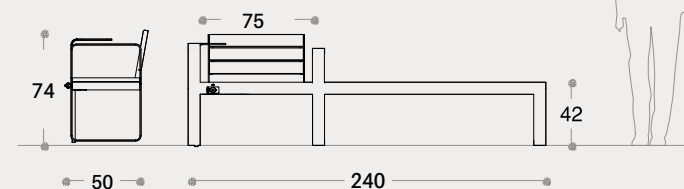

604-SOL
MODULO SOLARE / SOLAR POWER MODULE

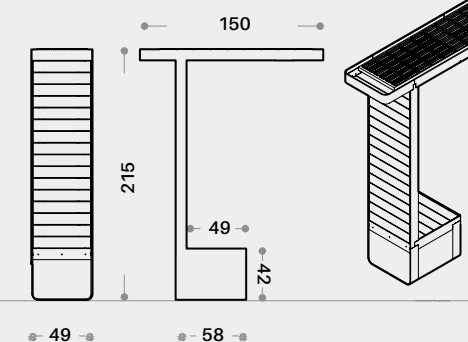



prodotti modulari
modular products



604-FIO-90
FIORIERA / PLANTER

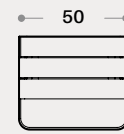
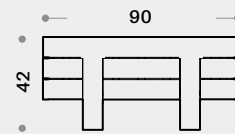
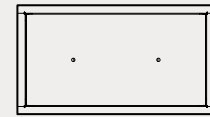
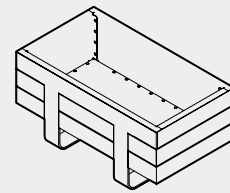

604-FIO-110
FIORIERA / PLANTER

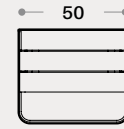
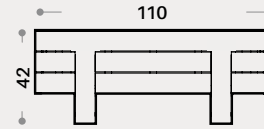
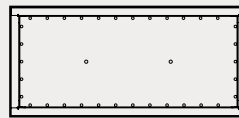
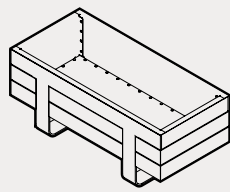

604-FIO-135
FIORIERA / PLANTER

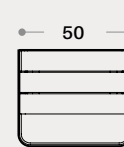
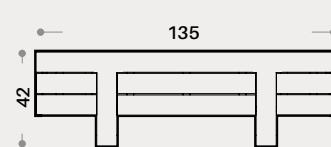
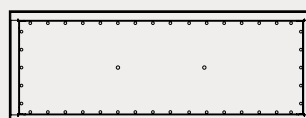
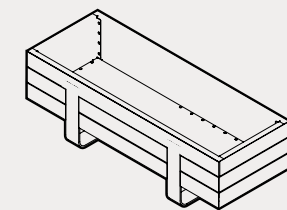

604-CO-M
CESTINO CON RIVESTIMENTO IN METALLO /
METAL COVERED LITTER BIN



Designer	Dimcar Design Department
Materiali / Materials	Acciaio zincato / Galvanized steel
Fissaggio / Fixing	Predisposizione per tasselli / Predisposition for dowels
Plus / Plus	Posacenere / Ashtray



604-CO-L
CESTINO CON RIVESTIMENTO IN LEGNO /
WOOD COVERED LITTER BIN



Designer	Dimcar Design Department
Materiali / Materials	Acciaio zincato, Listoni in legno / Galvanized steel, Wooden planks
Fissaggio / Fixing	Predisposizione per tasselli / Predisposition for dowels
Plus / Plus	Posacenere / Ashtray

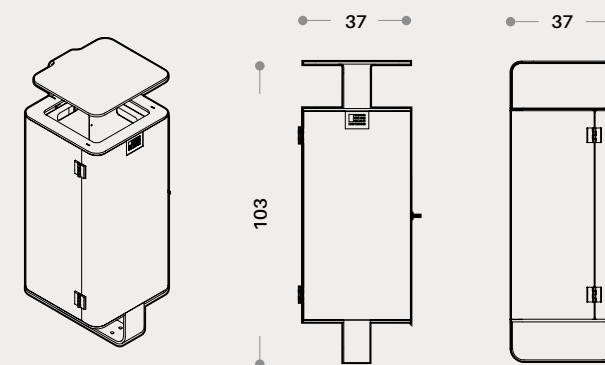

Creata per rispondere ai bisogni di aggregazione e connessione delle persone negli spazi pubblici, NOI è una linea multifunzionale e modulare che offre moltissime possibilità di combinazione: grazie alla sua versatilità è perfetta per adattarsi a spazi e funzioni diverse o creare nuove geometrie.

Created to gather and connect people in public spaces, NOI it's a multifunctional and modular line that can be combined in many ways. Due to its versatile nature, it is ideal for adapting to different spaces and functions or creating new geometries.



linea

NOI

TRASFORMA SPAZI
PUBBLICI IN LUOGHI
DI INCONTRO E
RELAZIONE PER LA
COMUNITÀ.



*TRANSFORM PUBLIC SPACES INTO
MEETING AND CONNECTION PLACES
FOR THE COMMUNITY.*





linea NOI
NOI line





INDEX LINEA



606-PE-COMP1

pag. 40



606-PE-D-COMP1

pag. 42



606-M

pag. 45



606-M-S

pag. 45

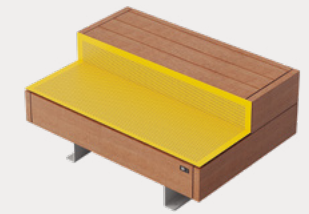

606-M-SL

pag. 45

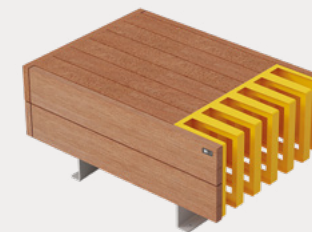

606-M-R

pag. 46



606-M-SF

ppag. 46



606-M-F

pag. 46



606-PO

pag. 47



606-CE

pag. 48





Noi

606-PE-COMP1

PENSILINA /
SHELTER

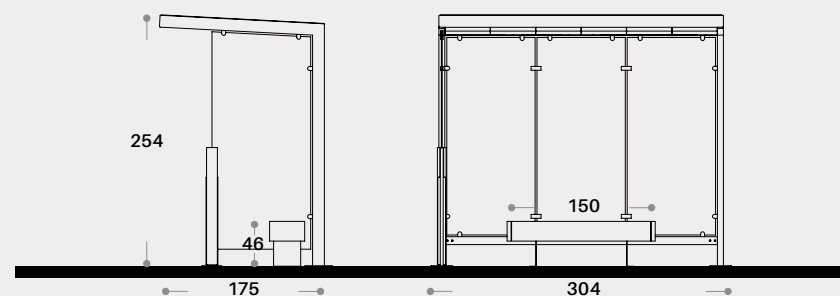

Designer	Dimcar Design Department
Dimensioni / Sizes	304x175 cm H 254 cm - 519 kg
Materiali / Materials	Acciaio zincato, Listoni in legno, Vetro stratificato / Galvanized steel, Wooden planks, Laminated glass
Fissaggio / Fixing	Predisposizione per zanche / By means of metal clamps
Plus / Plus	Illuminazione, Parete laterale vetrata, Panca / Lighting, Glass side wall, Seat





Noi

606-PE-D-COMP1

PENSILINA DOPPIA /
DOUBLE SHELTER

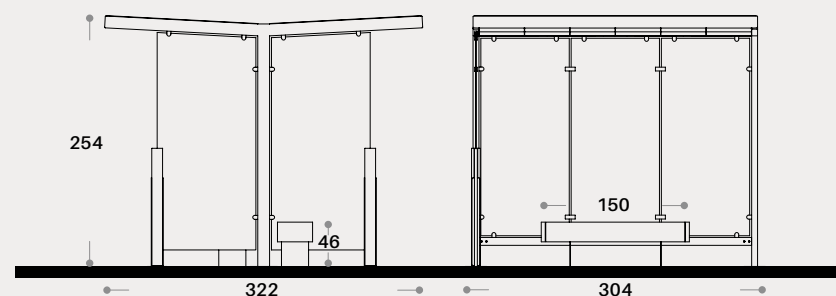

Designer	Dimcar Design Department
Dimensioni / Sizes	304x322 cm H 254 cm - 775 kg
Materiali / Materials	Acciaio zincato, Listoni in legno, Vetro stratificato / Galvanized steel, Wooden planks, Laminated glass
Fissaggio / Fixing	Predisposizione per zanche / By means of metal clamps
Plus / Plus	Illuminazione, Pareti laterali in vetro, Panche / Lighting, Glass side walls, Seats





prodotti modulabili

modular products

Designer	Dimcar Design Department
Dimensioni / Sizes	130x90 cm H 60 cm
Materiali / Materials	Acciaio zincato, Listoni in legno / Galvanized steel, Wooden planks
Fissaggio / Fixing	Predisposizione per tasselli / Predisposition for dowels



606-M
SEDUTA / SEAT

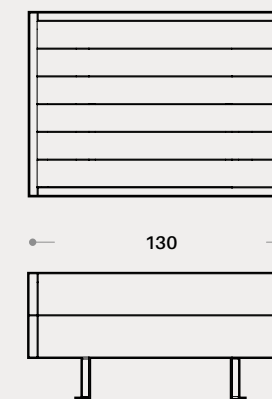
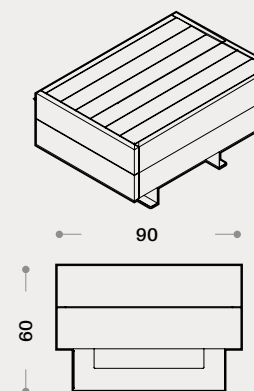

606-M-SL
SEDUTA CON SCHIENALE /
BENCH WITH BACKREST

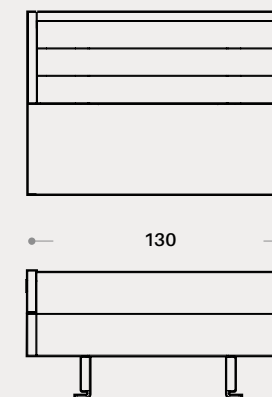
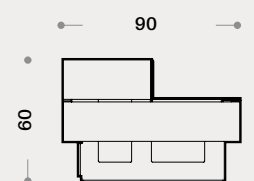

606-M-S
SEDUTA CON SCHIENALE
E RICARICA USB/
BENCH WITH USB CHARGER

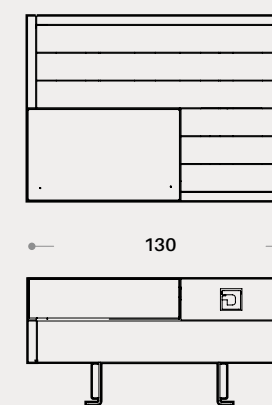
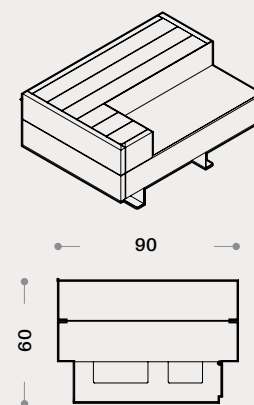



prodotti
modulabili

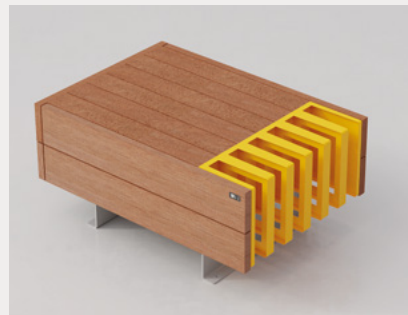

606-M-R
SEDUTA CON RASTRELLIERA /
SEAT WITH BIKE RACK

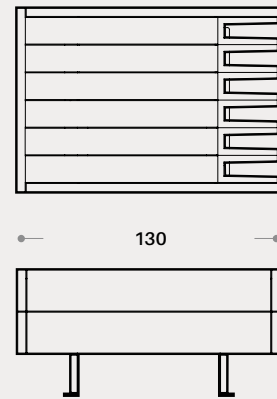
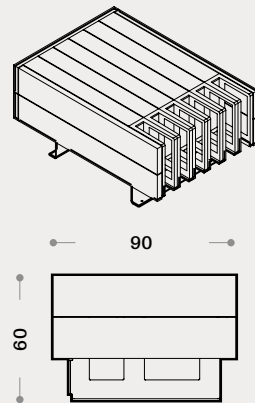

606-M-SF
SEDUTA CON FIORIERA /
SEAT WITH PLANTER

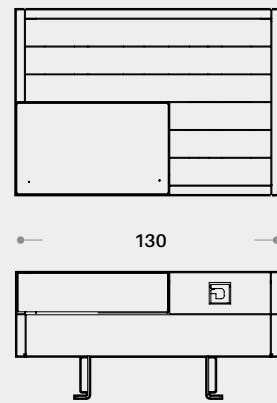
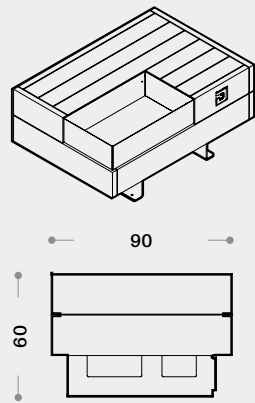

606-M-F
FIORIERA / PLANTER

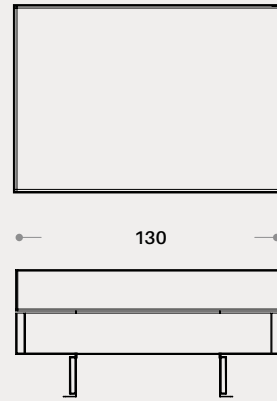
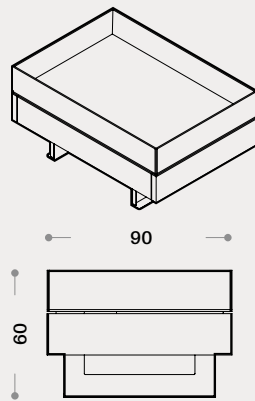

Portabici NOI

606-P0
NOI BIKE RACK

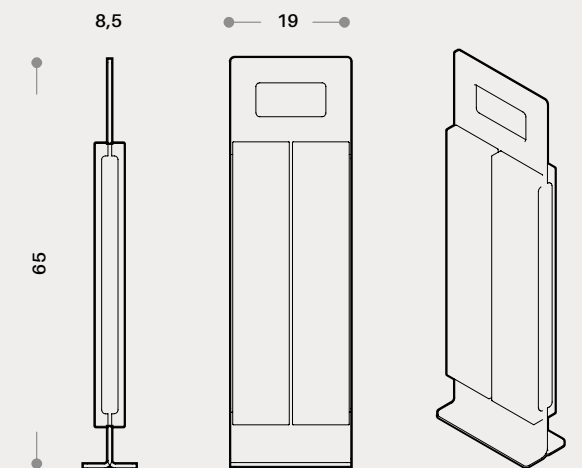

Designer	Dimcar Design Department
Dimensioni / Sizes	19x8,5 cm H 65 cm - 10 kg
Materiali / Materials	Acciaio zincato, Listoni in legno / Galvanized steel, Wooden planks
Fissaggio / Fixing	Predisposizione per tasselli / Predisposition for dowels



Cestone NOI

606-CE

NOI LARGE TRASH BIN

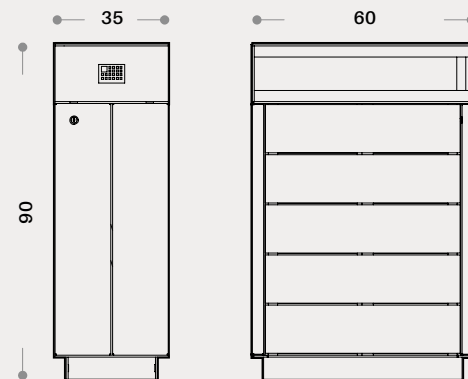

Designer	Dimcar Design Department
Dimensioni / Sizes	60x35 cm H 90 cm - 70 lt - 51 kg
Materiali / Materials	Acciaio zincato, Listoni in legno / Galvanized steel, Wooden planks
Fissaggio / Fixing	Predisposizione per tasselli / Predisposition for dowels
Plus / Plus	Posacenere / Ashtray



Il design si caratterizza per un equilibrio perfetto tra forme geometriche e giochi cromatici, con pannelli traforati che aggiungono un tocco di dinamismo e leggerezza: un dialogo armonioso tra gli elementi che si adattano perfettamente a diversi contesti e funzioni.

A design that combines geometric shapes with chromatic games, with perforated panels that add dynamism and lightness. A balanced dialogue between elements that can be adjusted to different contexts and functions.



linea
KOMETE

DAI NUOVA VITA ALLA
TUA CITTÀ CON IL
DESIGN CREATIVO
DELLA LINEA KOMETE.

*GIVE NEW LIFE TO YOUR CITY WITH THE
CREATIVE DESIGN OF THE KOMETE LINE.*





linea KOMETE
linea KOMETE



KOMETE INDEX LINEA



D818
pag. 56



D818-S
pag. 58



D819-BIS
pag. 60



D819
pag. 61



D820
pag. 61

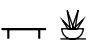

D821
pag. 62



D822
pag. 62



D824
pag. 63

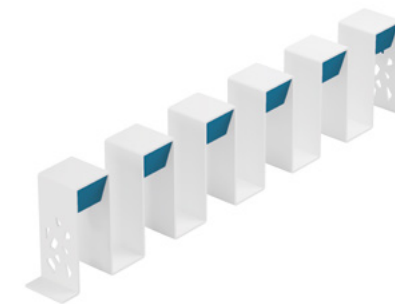

D825
pag. 63





Komete

D818

PENSILINA/ SHELTER

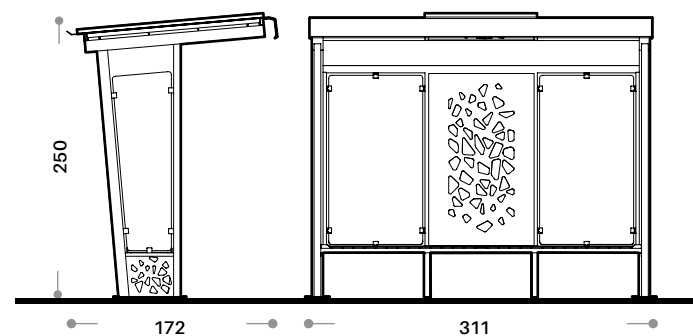

Designer	Dimcar Design Department
Dimensioni / Sizes	311x172 cm H 250 cm - 616 kg
Materiali / Materials	Acciaio zincato, Policarbonato compatto fumè, Listoni in legno, Vetro stratificato / Galvanized Steel, Tinted compact polycarbonate, Wooden planks, Laminated glass
Fissaggio / Fixing	Ancoraggio chimico / Chemical anchoring
Optional	Illuminazione / Lighting





Komete Solar

D818-S

PENSILINA/ SOLAR SHELTER

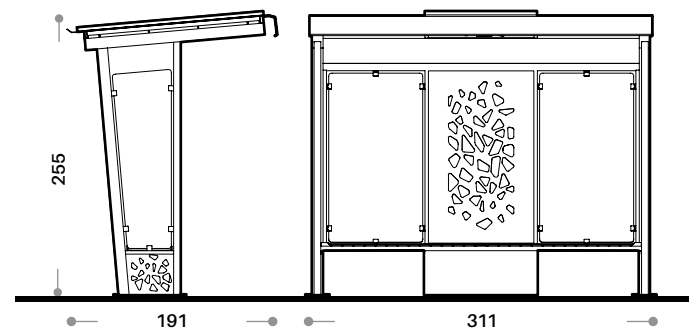

Designer	Dimcar Design Department
Dimensioni / Sizes	311x191 cm H 255 cm - 676 kg
Materiali / Materials	Acciaio zincato, Policarbonato compatto fumè, Listoni in legno, Vetro stratificato / Galvanized Steel, Tinted compact polycarbonate, Wooden planks, Laminated glass
Fissaggio / Fixing	Ancoraggio chimico / Chemical anchoring
Plus / Plus	Illuminazione, prese usb, ricarica wireless, impianto fotovoltaico / Lighting, usb socket, wireless charger, solar power module





Panchina Komete

D819-BIS
KOMETE BENCH

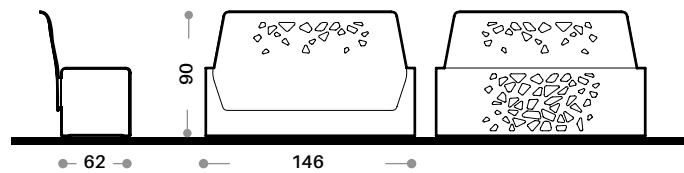

Designer	Dimcar Design Department
Dimensioni / Sizes	146x62 cm H 90 cm - 147 kg
N. posti / No. of seats	3
Materiali / Materials	Acciaio zincato / Galvanized steel
Fissaggio / Fixing	Predisposizione per tasselli / Predisposition for dowels



Panca Komete

D819
KOMETE SEAT

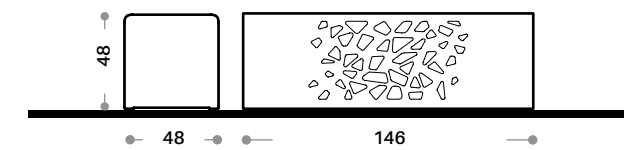

Designer	Dimcar Design Department
Dimensioni / Sizes	146x48 cm H 48 cm - 81 kg
N. posti / No. of seats	3
Materiali / Materials	Acciaio zincato / Galvanized steel
Fissaggio / Fixing	Predisposizione per tasselli / Predisposition for dowels



Fioriera Komete

D820
KOMETE FLOWER BOX

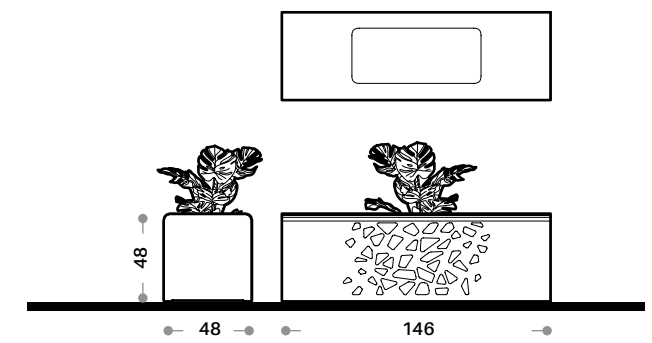
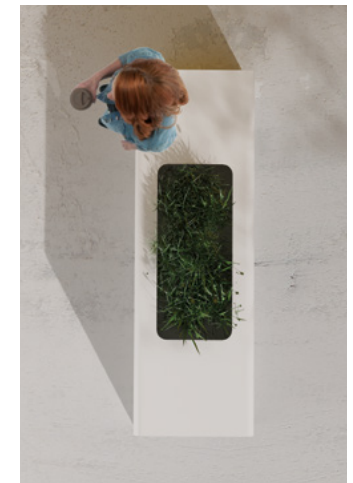

Designer	Dimcar Design Department
Dimensioni / Sizes	146x48 cm H 48 cm - 86,0 kg
Materiali / Materials	Acciaio zincato / Galvanized steel
Fissaggio / Fixing	Predisposizione per tasselli / Predisposition for dowels



Cestone Komete

D821

KOMETE LARGE TRASH BIN

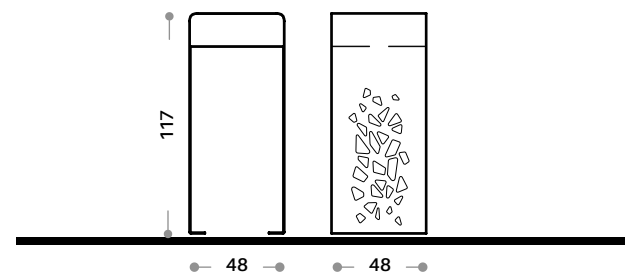

Designer	Dimcar Design Department
Dimensioni / Sizes	48x48 cm H 117 cm - 130 l - 77 kg
Materiali / Materials	Acciaio zincato / Galvanized steel
Fissaggio / Fixing	Predisposizione per tasselli / Predisposition for dowels
Optionals / Optionals	Posacenere / Ashtray



Cestino Komete

D822

KOMETE LITTER BIN

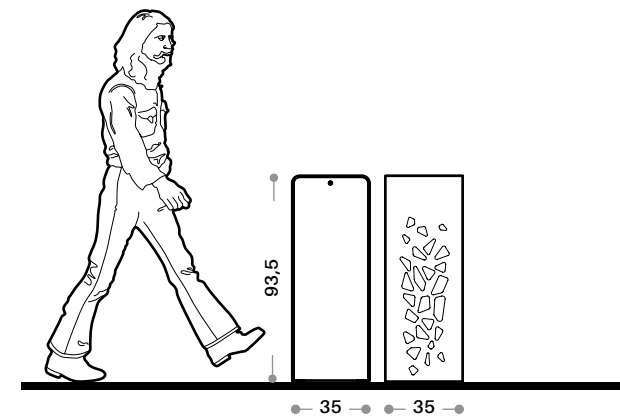

Designer	Dimcar Design Department
Dimensioni / Sizes	35x35 cm H 93,5 cm - 35 l - 37 kg
Materiali / Materials	Acciaio zincato / Galvanized steel
Fissaggio / Fixing	Predisposizione per tasselli / Predisposition for dowels
Optionals / Optionals	Posacenere / Ashtray



Portabici Komete

D824

KOMETE BIKE STAND

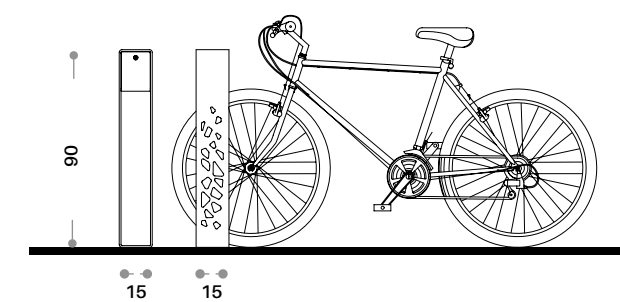

Designer	Dimcar Design Department
Dimensioni / Sizes	15x15 cm H 90 cm - 14 kg
N° posto bici / N° bike space	1
Materiali / Materials	Acciaio zincato / Galvanized steel
Fissaggio / Fixing	Predisposizione per tasselli / Predisposition for dowels



Rastrelliera Komete

D825

KOMETE BIKE RACK

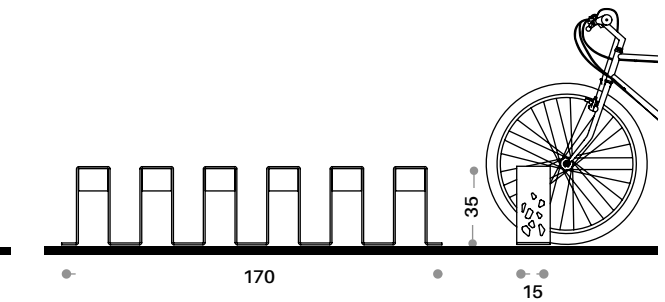

Designer	Dimcar Design Department
Dimensioni / Sizes	170x15 cm H 35 cm - 58 kg
N° posto bici / N° bike space	6
Materiali / Materials	Acciaio zincato / Galvanized steel
Fissaggio / Fixing	Predisposizione per tasselli / Predisposition for dowels

Punto di forza è la sua grande attenzione all'inclusività: design, materiali e accortezze costruttive la rendono capace di adattarsi a tutte le esigenze, senza barriere, differenze o difficoltà di sorta.

What sets it apart is its emphasis on inclusiveness: its design, materials, and construction enable it to adapt to all needs without any barriers, differences, or difficulties of any kind.

linea

PINCH

inclusion

CREA AMBIENTI INCLUSIVI E FUNZIONALI CON SOLUZIONI MODULARI E VERSATILI.

CREATE INCLUSIVE AND FUNCTIONAL ENVIRONMENTS WITH MODULAR AND VERSATILE SOLUTIONS.



linea PINCH
PINCH line



linea

PINCH



linea

PINCH INDEX LINEA

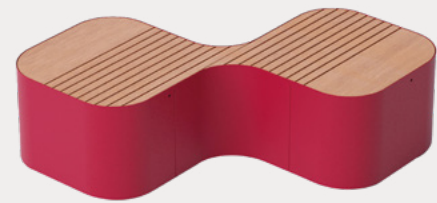

608-2M

pag. 70

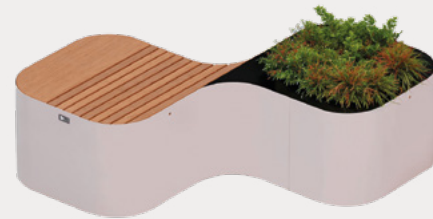

608-2M-F

pag. 71

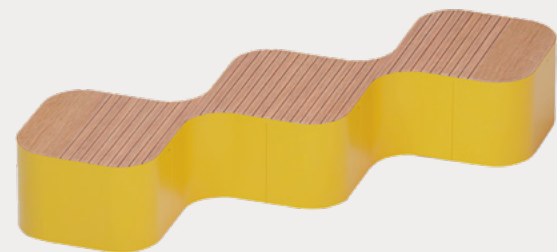

608-3ML

pag. 72

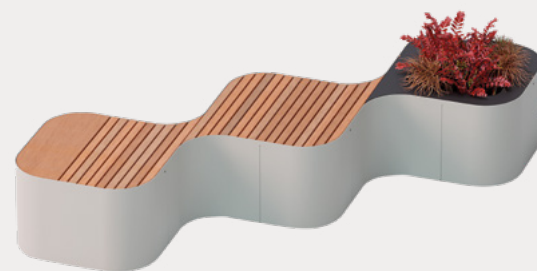

608-3ML-F

pag. 73

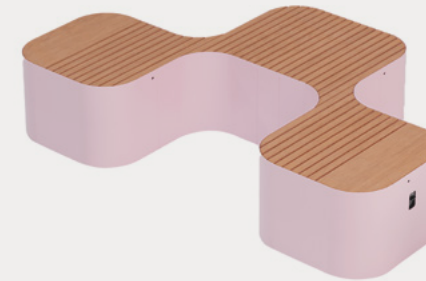

608-3M

pag. 74



608-3M-F

pag. 75



inclusion



linea

PINCH

inclusion

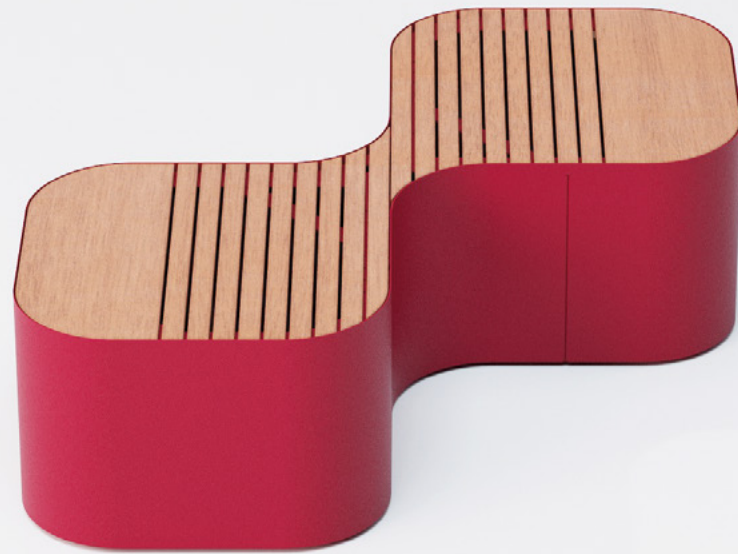

608-2M

PANCA A 2 MODULI PER SOLE SEDUTE / BENCH WITH 2 MODULES FOR SEATING ONLY

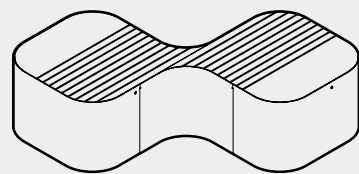

140

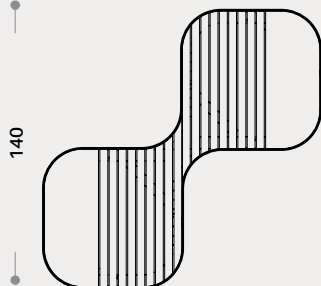

140

42

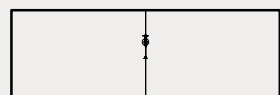

Designer	Dimcar Design Department
Dimensioni / Sizes	140x140 cm H 42 cm - 67 Kg
Materiali / Materials	Acciaio zincato, Listoni in legno / Galvanized steel, Wooden planks
Fissaggio / Fixing	Predisposizione per tasselli / Predisposition for dowels
Optional / Optional	presa USB, caricatore wireless / USB socket, wireless charger

inclusion

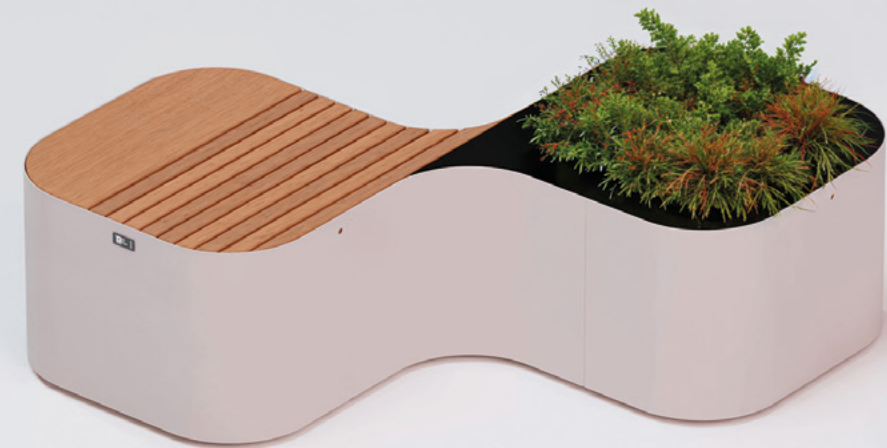

608-2M-F

PANCA A 2 MODULI CON SEDUTA E FIORIERA / 2-MODULE BENCH WITH SEAT AND PLANTER

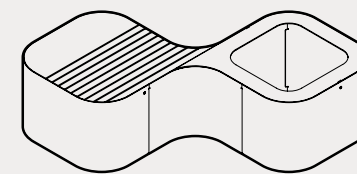

140

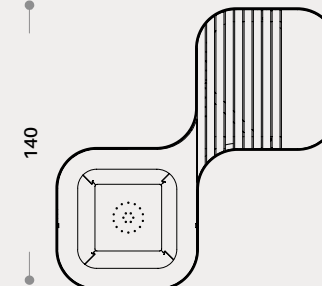

140

42

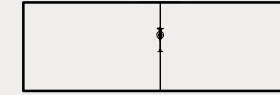

Designer	Dimcar Design Department
Dimensioni / Sizes	140x140 cm H 42 cm - 67 Kg
Materiali / Materials	Acciaio zincato, Listoni in legno / Galvanized steel, Wooden planks
Fissaggio / Fixing	Predisposizione per tasselli / Predisposition for dowels
Optional / Optional	presa USB, caricatore wireless / USB socket, wireless charger



linea

PINCH

inclusion

inclusion



608-3ML

PANCA A 3 MODULI IN LINEA
PER SOLE SEDUTE /
BENCH WITH 3 IN-LINE MODULES
FOR SEATING ONLY

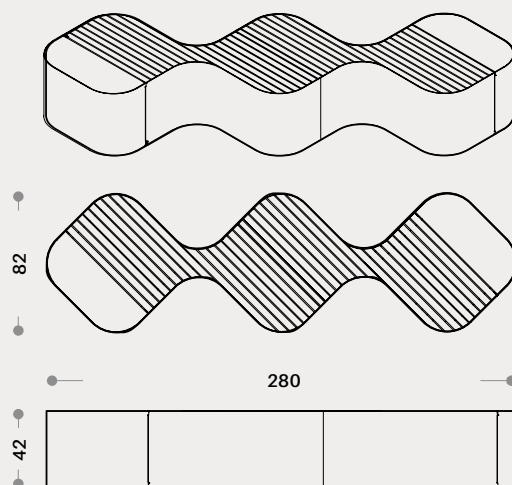

Designer	Dimcar Design Department
Dimensioni / Sizes	280x82 cm H 42 cm - 101 Kg
Materiali / Materials	Acciaio zincato, Listoni in legno / Galvanized steel, Wooden planks
Fissaggio / Fixing	Predisposizione per tasselli / Predisposition for dowels
Optional / Optional	Presse USB, Caricatore wireless / USB socket, Wireless charger

608-3ML-F

PANCA A 3 MODULI IN LINEA CON
2 SEDUTE E FIORIERA /
3-MODULE BENCH WITH
2 SEATS AND PLANTER

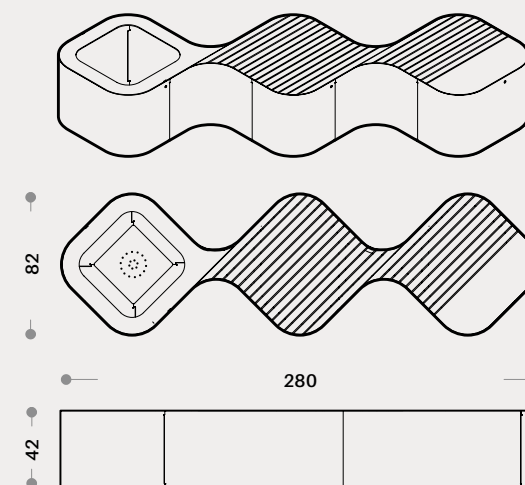
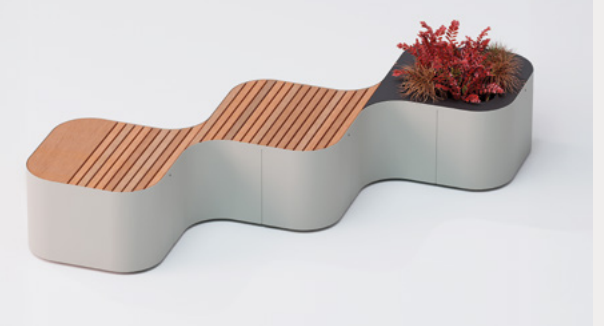

Designer	Dimcar Design Department
Dimensioni / Sizes	280x82 cm H 42 cm - 121 Kg
Materiali / Materials	Acciaio zincato, Listoni in legno / Galvanized steel, Wooden planks
Fissaggio / Fixing	Predisposizione per tasselli / Predisposition for dowels
Optional / Optional	Presse USB, Caricatore wireless / USB socket, Wireless charger



linea

PINCH

inclusion

inclusion



608-3M
PANCA A 3 MODULI PER SOLE SEDUTE/
BENCH WITH 3 MODULES FOR SEATING ONLY

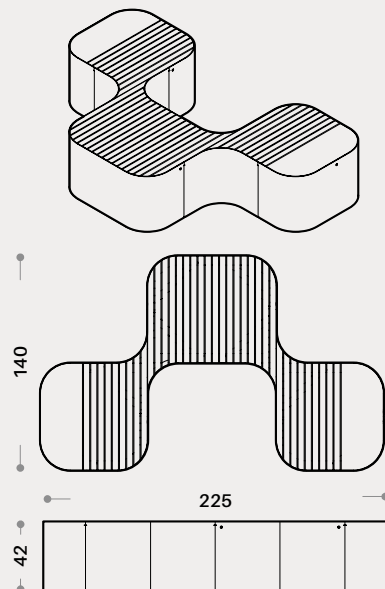

Designer	Dimcar Design Department
Dimensioni / Sizes	225x140 cm H 42 cm - 106 Kg
Materiali / Materials	Acciaio zincato, Listoni in legno / Galvanized steel, Wooden planks
Fissaggio / Fixing	Predisposizione per tasselli / Predisposition for dowels
Optional / Optional	presa USB, caricatore wireless / USB socket, wireless charger

608-3M-F
PANCA A 3 MODULI CON 2 SEDUTE E FIORIERA/
3-MODULE BENCH WITH 2 SEATS AND PLANTER

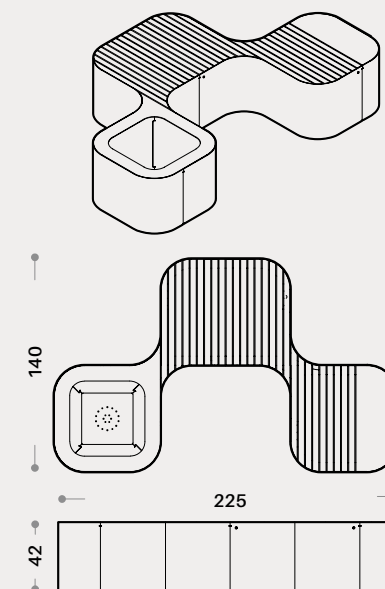

Designer	Dimcar Design Department
Dimensioni / Sizes	225x140 cm H 42 cm - 106 Kg
Materiali / Materials	Acciaio zincato, Listoni in legno / Galvanized steel, Wooden planks
Fissaggio / Fixing	Predisposizione per tasselli / Predisposition for dowels
Optional / Optional	presa USB, caricatore wireless / USB socket, wireless charger



Altezze a misura di bambino, protezioni antiurto, materiali di alta qualità: tutto prende vita, brio e allegria. Anche imparare le regole per una corretta raccolta differenziata diventa un'attività coinvolgente e senza sforzo.

High-quality materials, child-friendly heights, and shock-resistant protection all combine to create fun and joy. The rules for proper recycling become an engaging and effortless activity.



linea



SPAZI URBANI A MISURA DI BAMBINO!

PROGETTA SPAZI URBANI SICURI E ACCOGLIENTI CON L'UNICA LINEA SUL MERCATO PENSATA PER I PIÙ PICCOLI.

DESIGN SAFE AND WELCOMING URBAN SPACES WITH THE ONLY PRODUCT LINE ON THE MARKET DESIGNED FOR YOUNG CHILDREN.



DIMCAR
CityLife Design







INDEXLINEA



G553 pag. 82 **D869** pag. 84

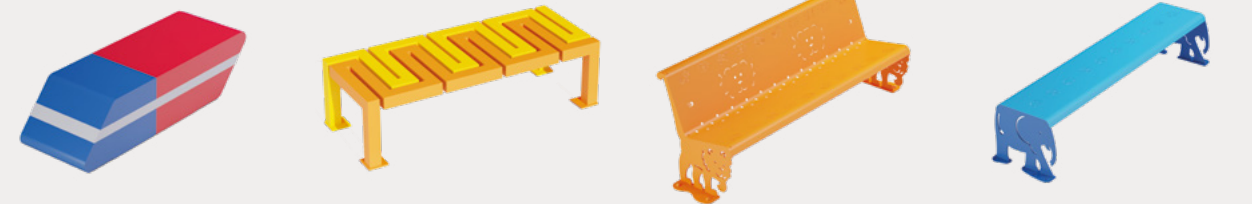

D870 pag. 85 **D833** pag. 86 **1139** pag. 87 **1138P** pag. 88

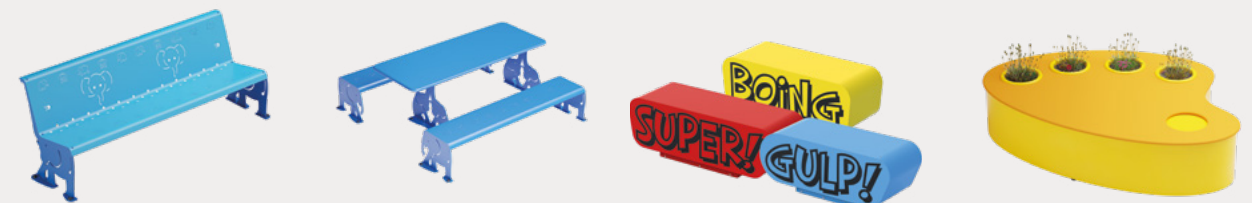

1138 pag. 88 **485** pag. 88 **D874** pag. 90 **D871** pag. 91



G557 pag. 93 **D866-C** pag. 94 **D866-T** pag. 95 **D866-P** pag. 95

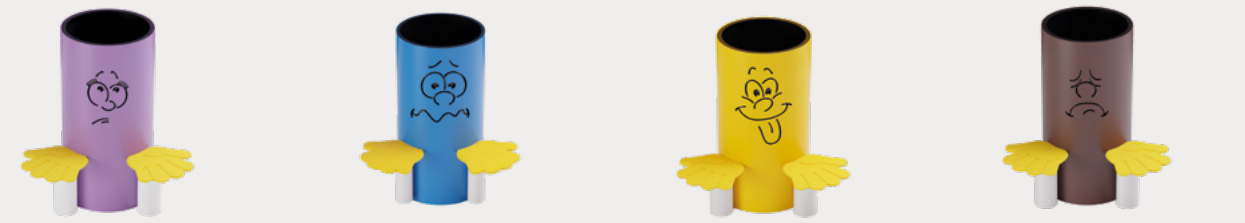

D866-M pag. 95 **D866-V** pag. 95 **D866-G** pag. 95 **D866-R** pag. 95



G556 pag. 96 **D873** pag. 97 **D832** pag. 98 **D858** pag. 103



D867 pag. 100 **D867-P** pag. 101 **D868** pag. 102

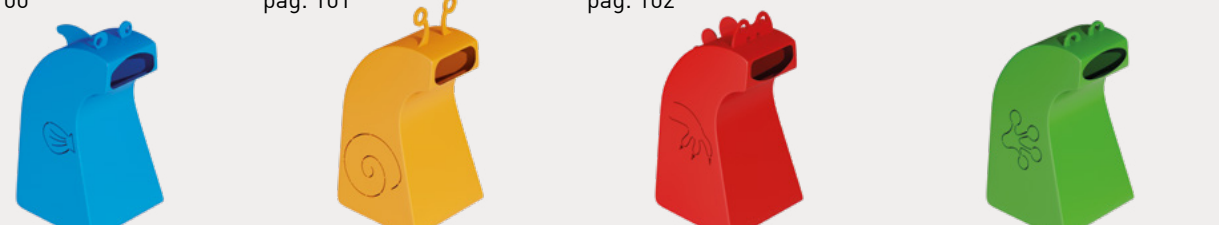

G548 pag. 104 **G549** pag. 104 **G551** pag. 104 **G552** pag. 104

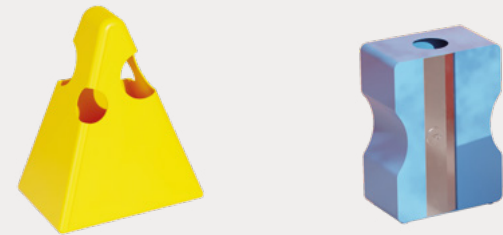

G560 pag. 106 **D872** pag. 107





Bruchetto

G553

COMPOSIZIONE / COMPOSITION



Designer	Gibillero Design
G553/C Dimensioni / Sizes	50x50 cm H 90 cm
G553/S Dimensioni / Sizes	115x40 cm H 40 cm
G553/P Dimensioni / Sizes	90x45 cm H 42 cm
Materiali / Materials	Acciaio zincato, Listoni in legno / Galvanized steel, Wooden planks
Fissaggio / Fixing	Predisposizione per tasselli / Predisposition for dowels

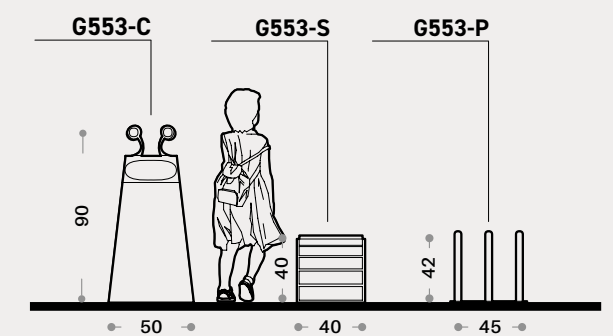



Librichina

D869

PANCHINA / BENCH

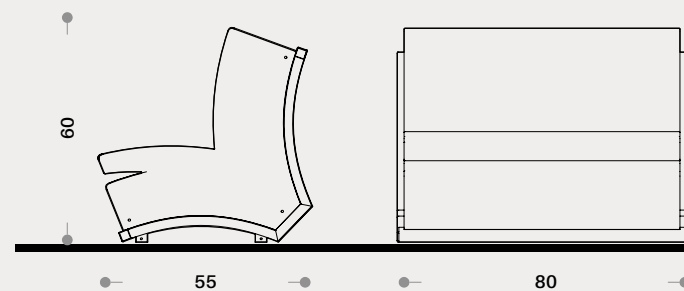

Designer	Dimcar Design Department
Dimensioni / Sizes	80x55 cm H 60 cm - 44 kg
N. posti / No. of seats	2
Materiali / Materials	Acciaio zincato / Galvanized steel
Fissaggio / Fixing	Predisposizione per tasselli / Predisposition for dowels

Gommina

D870

PANCA / SEAT

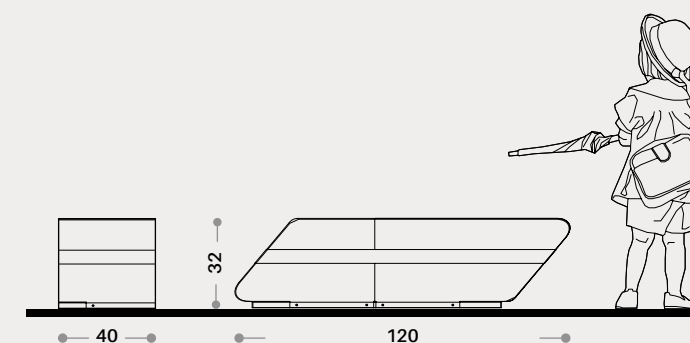

Designer	Dimcar Design Department
Dimensioni / Sizes	120x40cm H 32 cm - 37 kg
N. posti / No. of seats	2
Materiali / Materials	Acciaio zincato / Galvanized steel
Fissaggio / Fixing	Predisposizione per tasselli / Predisposition for dowels



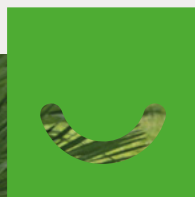

Baby snake

D833

PANCA / SEAT

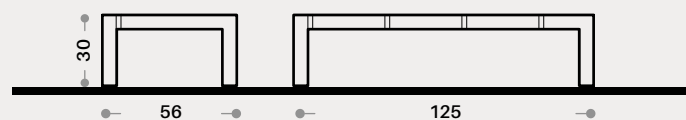
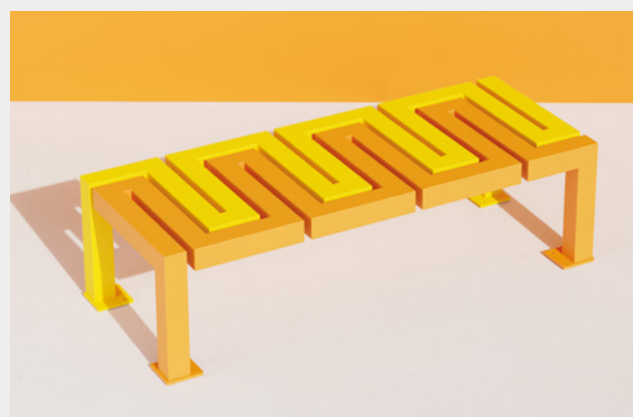

Designer	Dimcar Design Department
Dimensioni / Sizes	125x56 cm H 30 cm - 52 kg
N. posti / No. of seats	3
Materiali / Materials	Acciaio zincato / Galvanized steel
Fissaggio / Fixing	Predisposizione per tasselli / Predisposition for dowels



Kimba

1139

PANCHINA / BENCH

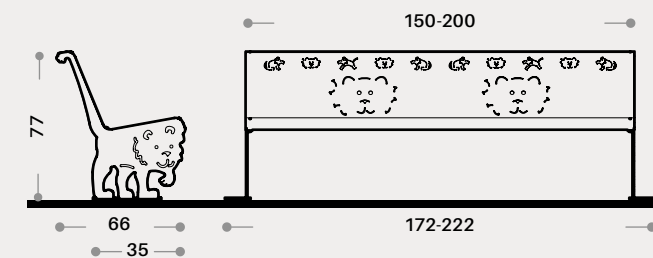

Designer	Dimcar Design Department
Dimensioni / Sizes	172-222x66 cm H 77 cm - 52 kg
N. posti / No. of seats	4
Materiali / Materials	Acciaio zincato / Galvanized steel
Fissaggio / Fixing	Predisposizione per tasselli / Predisposition for dowels



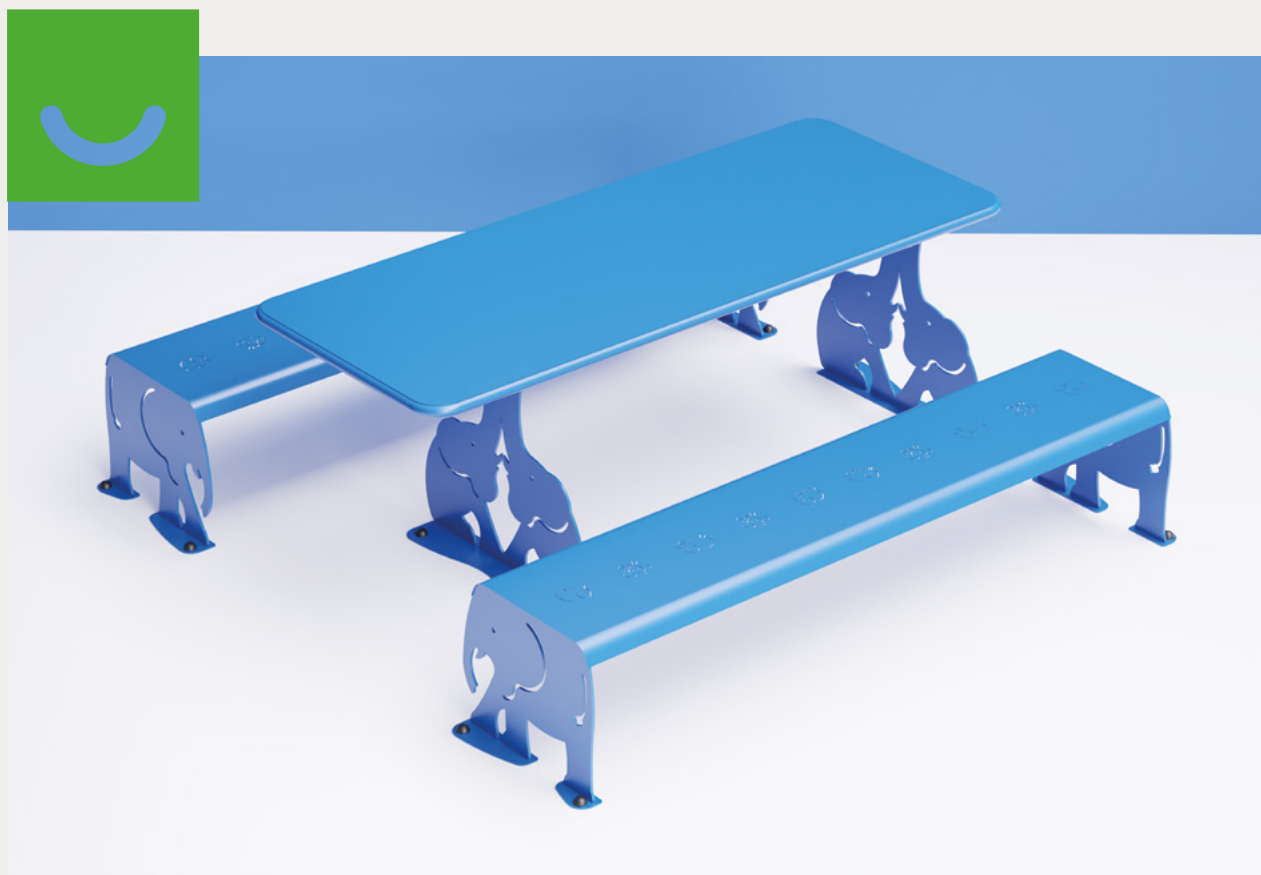

Dumbo



	1138-P PANCA / SEAT	1138 PANCHINA / BENCH	485 TAVOLO DA PICNIC / PICNIC TABLE
Designer	Dimcar Design Department		
Dimensioni / Sizes	214x52 cm H 42 cm	214x68 cm H 77 cm	212x218 cm H 78 cm
Materiali / Materials	Acciaio zincato / Galvanized steel		
Fissaggio / Fixing	Predisposizione per tasselli / Predisposition for dowels		

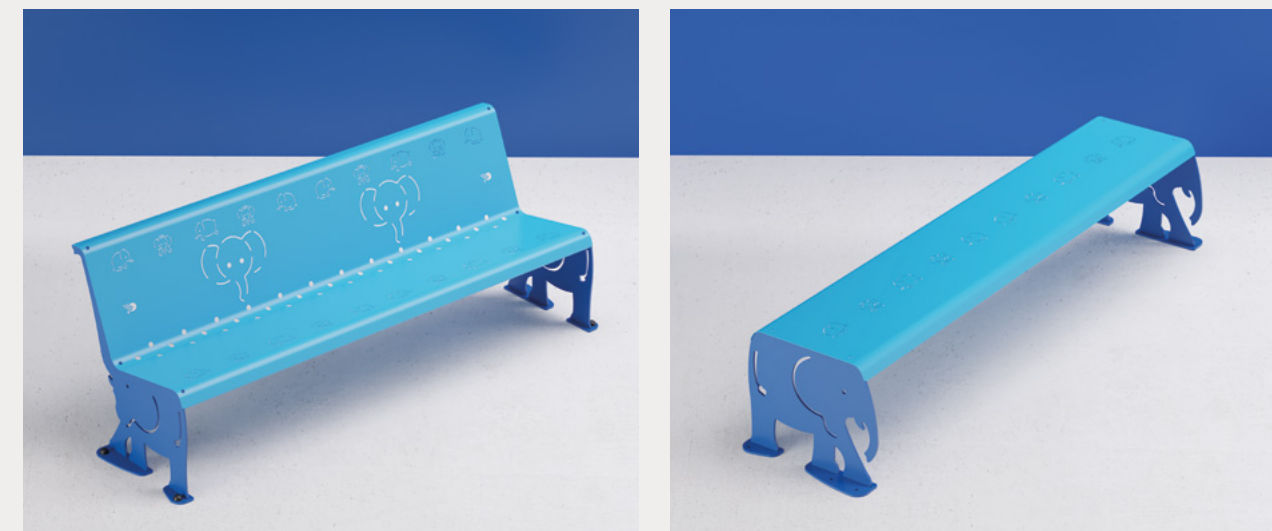

1138-P / PANCA / SEAT

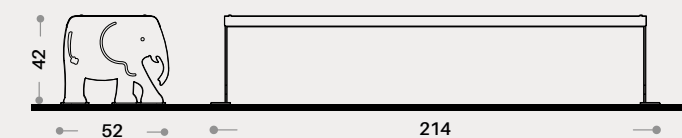

1138 / PANCHINA / BENCH

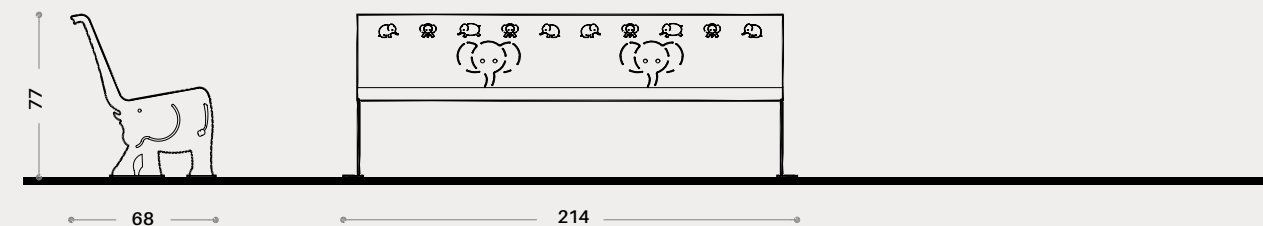

485 / TAVOLO DA PICNIC / PICNIC TABLE

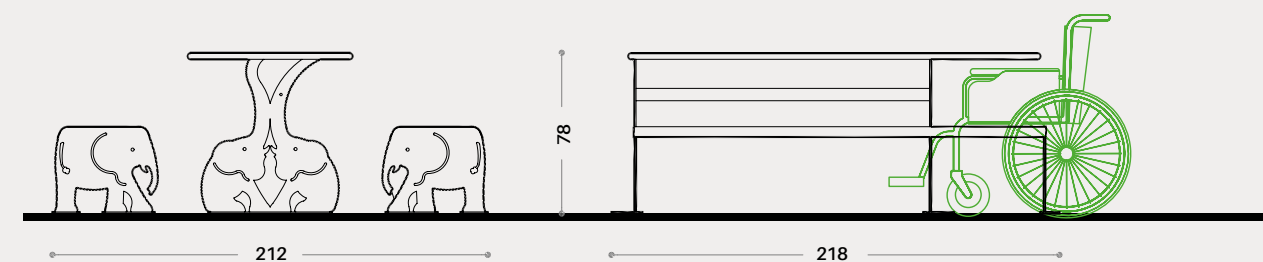



Fumettors

D874

SEDUTA / SEAT

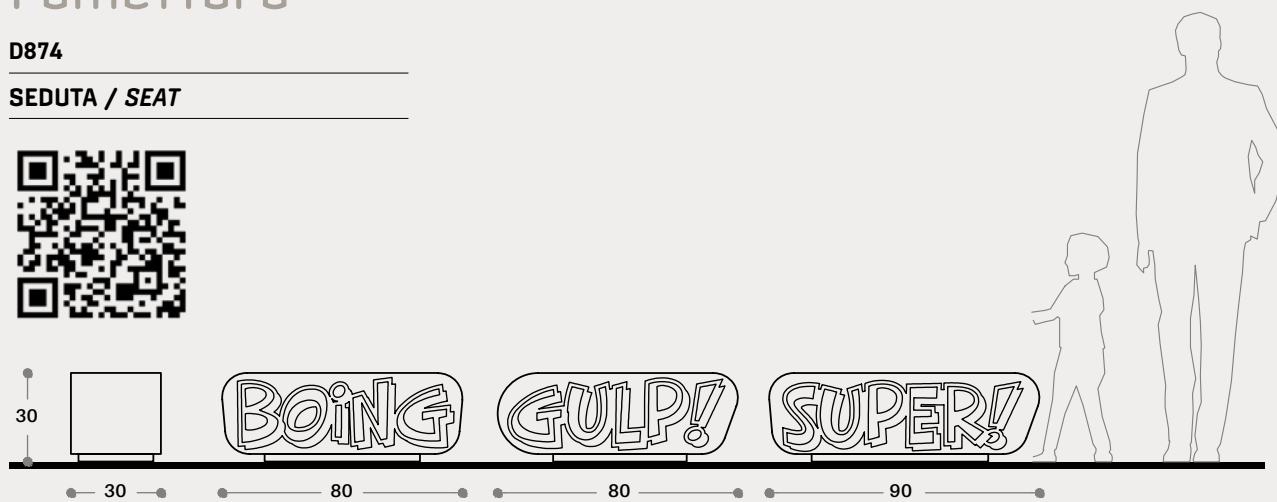

Designer	Dimcar Design Department
Dimensioni / Sizes	80X30 cm H 30 cm - 29 kg
N. posti / No. of seats	2
Materiali / Materials	Acciaio zincato / Galvanized steel
Fissaggio / Fixing	Predisposizione per tasselli / Predisposition for dowels



Fiorozza

D871

SEDUTA CON FIORIERA /
SEAT WITH PLANTER

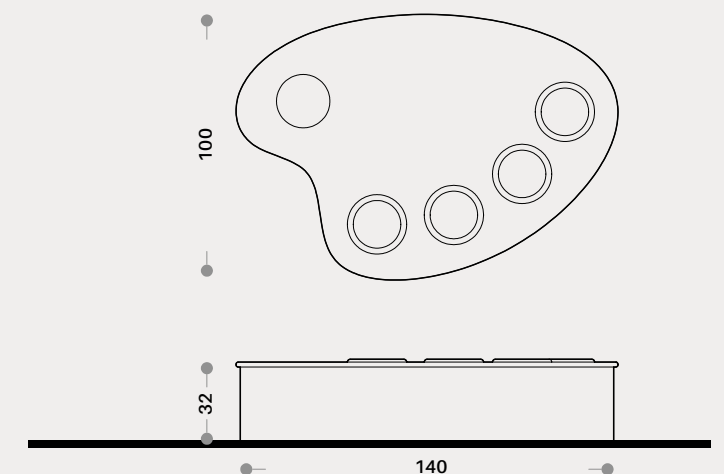

Designer	Dimcar Design Department
Dimensioni / Sizes	140x100cm H 32 cm - 81 kg
N. posti / No. of seats	3
Materiali / Materials	Acciaio zincato / Galvanized steel
Fissaggio / Fixing	Predisposizione per tasselli / Predisposition for dowels



Matita

G557

SEDUTA / SEAT

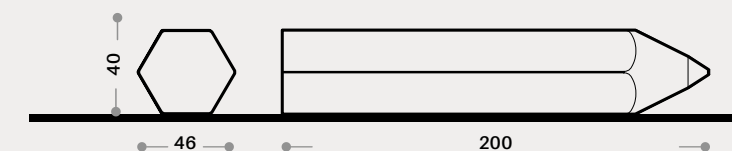

Designer	Gibillero Design
Dimensioni / Sizes	200x46 cm H 40 cm - 53 kg
N. posti / No. of seats	3
Materiali / Materials	Acciaio zincato / Galvanized steel
Fissaggio / Fixing	Predisposizione per tasselli / Predisposition for dowels



Panflors

SEDUTA CON FIORIERA /
SEAT WITH PLANTER

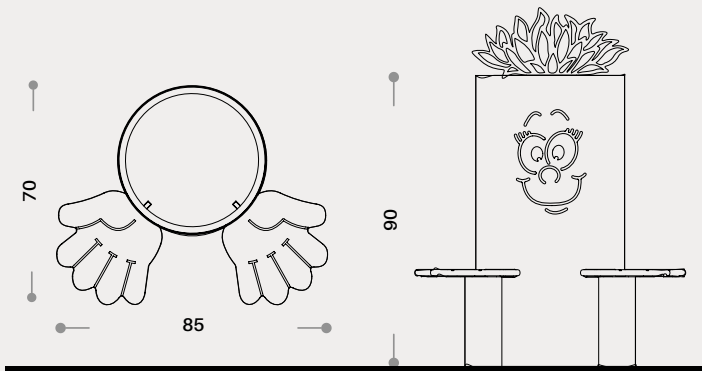

D866-C

Cetta la felicetta

Designer	Dimcar Design Department
Dimensioni / Sizes	85x70 cm H 90 cm - 110 kg
N. posti / No. of seats	2
Materiali / Materials	Acciaio zincato, Sedute in polystone / Galvanized steel, Polystone seatings
Fissaggio / Fixing	Predisposizione per tasselli / Predisposition for dowels

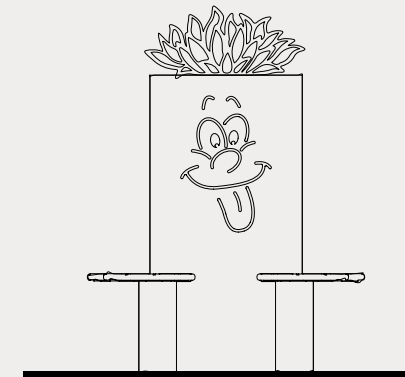

D866-G

Giorgione il simpaticone

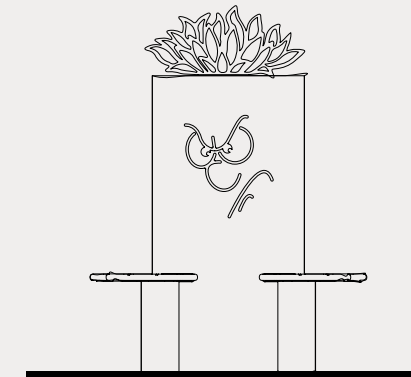

D866-P

Paolone il brontolone

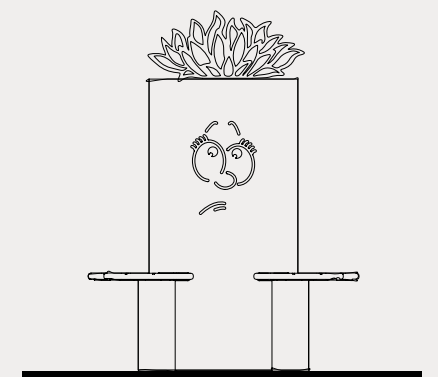

D866-M

Martina la timidina

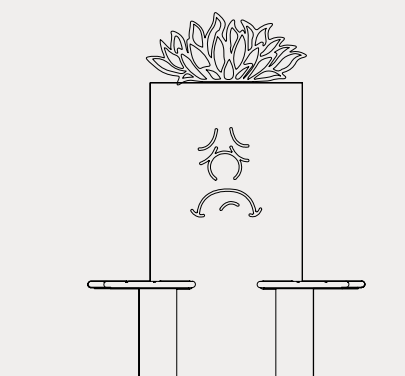

D866-R

Renato lo sconsolato

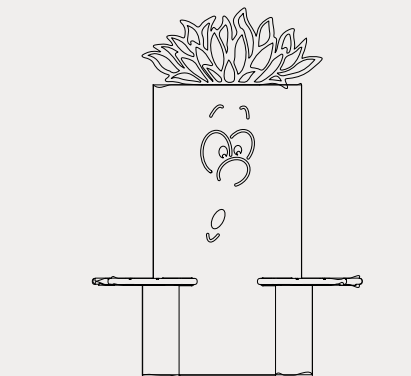

D866-T

Tito incuriosito

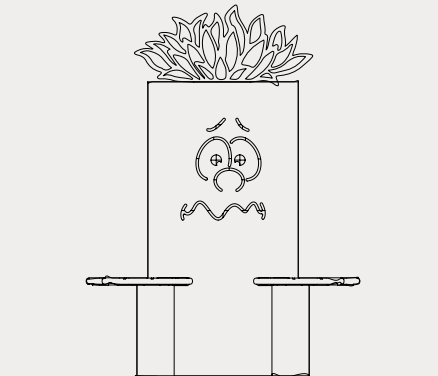

D866-V

Vito impaurito



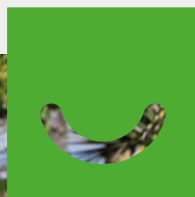

Tubetto

G556

SEDUTA CON FIORIERA /
SEAT WITH PLANTER

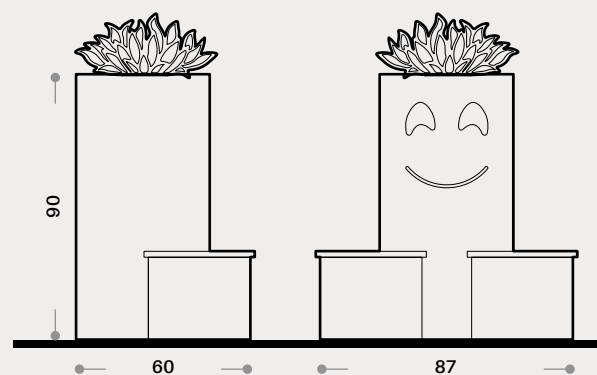

Designer	Gibillero Design
Dimensioni / Sizes	87x60cm H 90 cm - 61 kg
N. posti / No. of seats	2
Materiali / Materials	Acciaio zincato / Galvanized steel
Fissaggio / Fixing	Predisposizione per tasselli / Predisposition for dowels

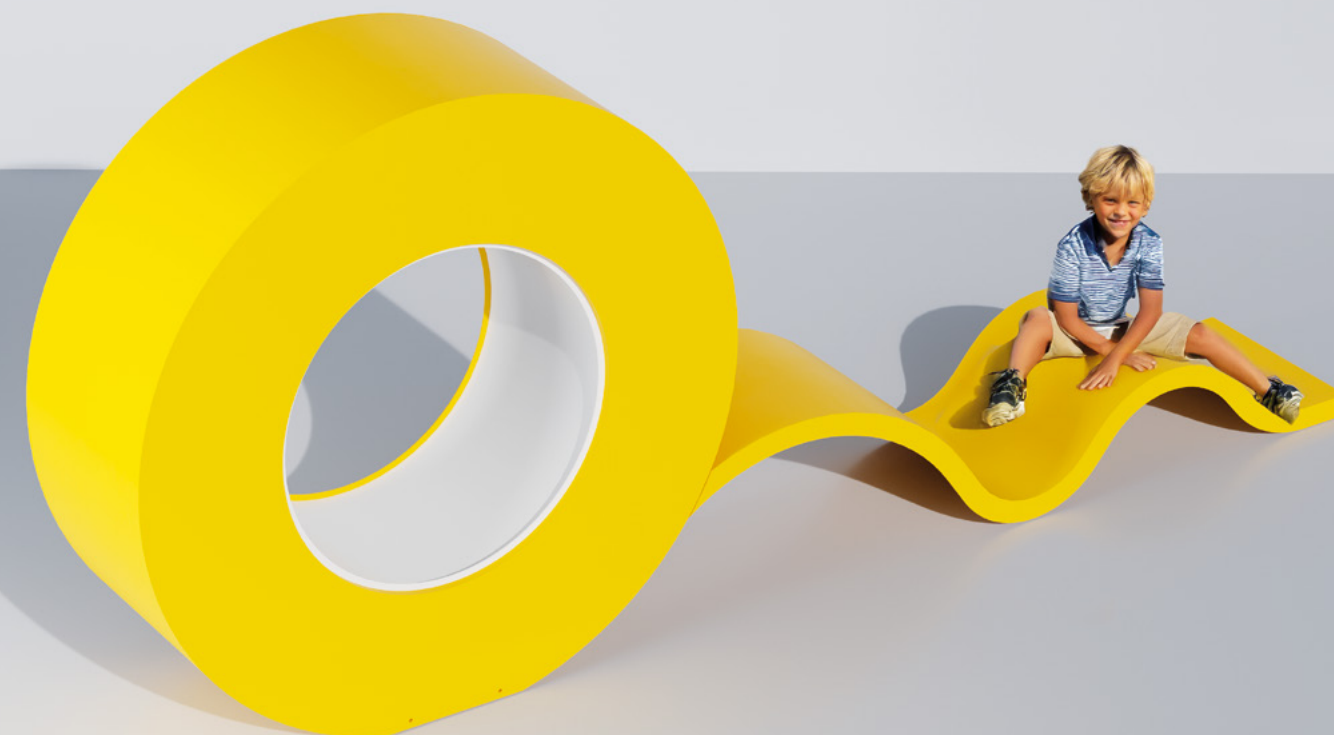

Nastrina

D873

SEDUTA / SEAT

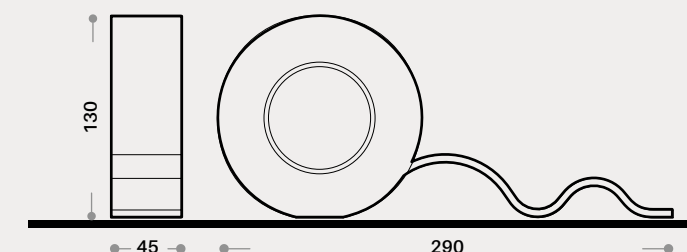

Designer	Dimcar Design Department
Dimensioni / Sizes	290x45cm H 130 cm - 118 kg
Materiali / Materials	Acciaio zincato / Galvanized steel
Fissaggio / Fixing	Predisposizione per tasselli / Predisposition for dowels



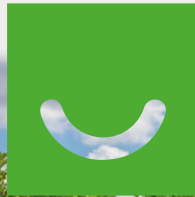

Loop

D832

TAVOLO MULTIATTIVITÀ /
MULTI-ACTIVITY TABLE

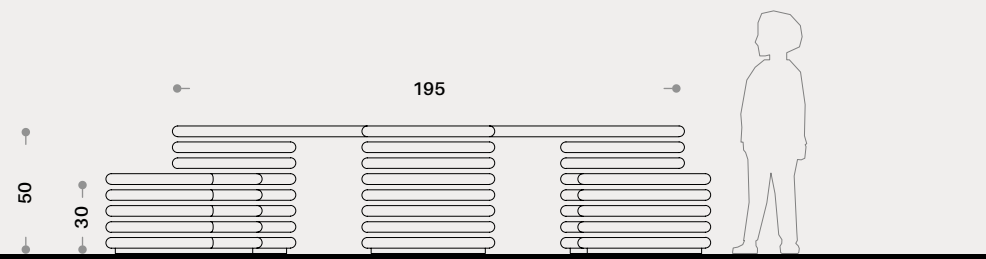
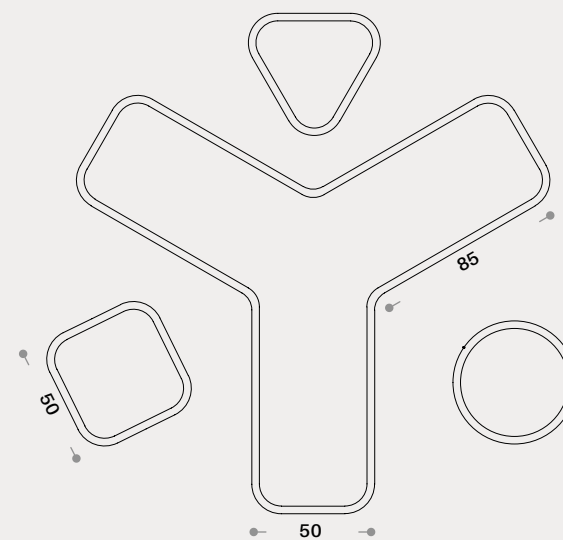

Designer	Dimcar Design Department
Dimensioni / Sizes	195x195 cm H 50 cm - 142 Kg
Materiali / Materials	Acciaio zincato / Galvanized steel
Fissaggio / Fixing	Predisposizione per tasselli / Predisposition for dowels





Cest-It

D867

CESTINO / LITTER BIN

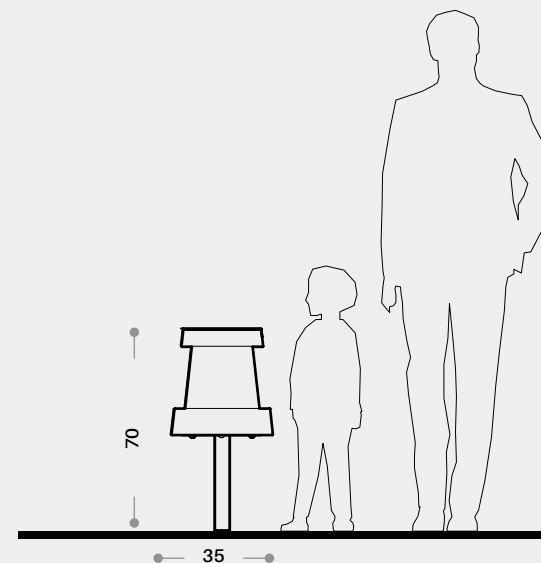

Designer	Dimcar Design Department
Dimensioni / Sizes	35x35 cm H 70 cm - 8 Kg
Materiali / Materials	Acciaio zincato / Galvanized steel
Fissaggio / Fixing	Cementazione / Cementation

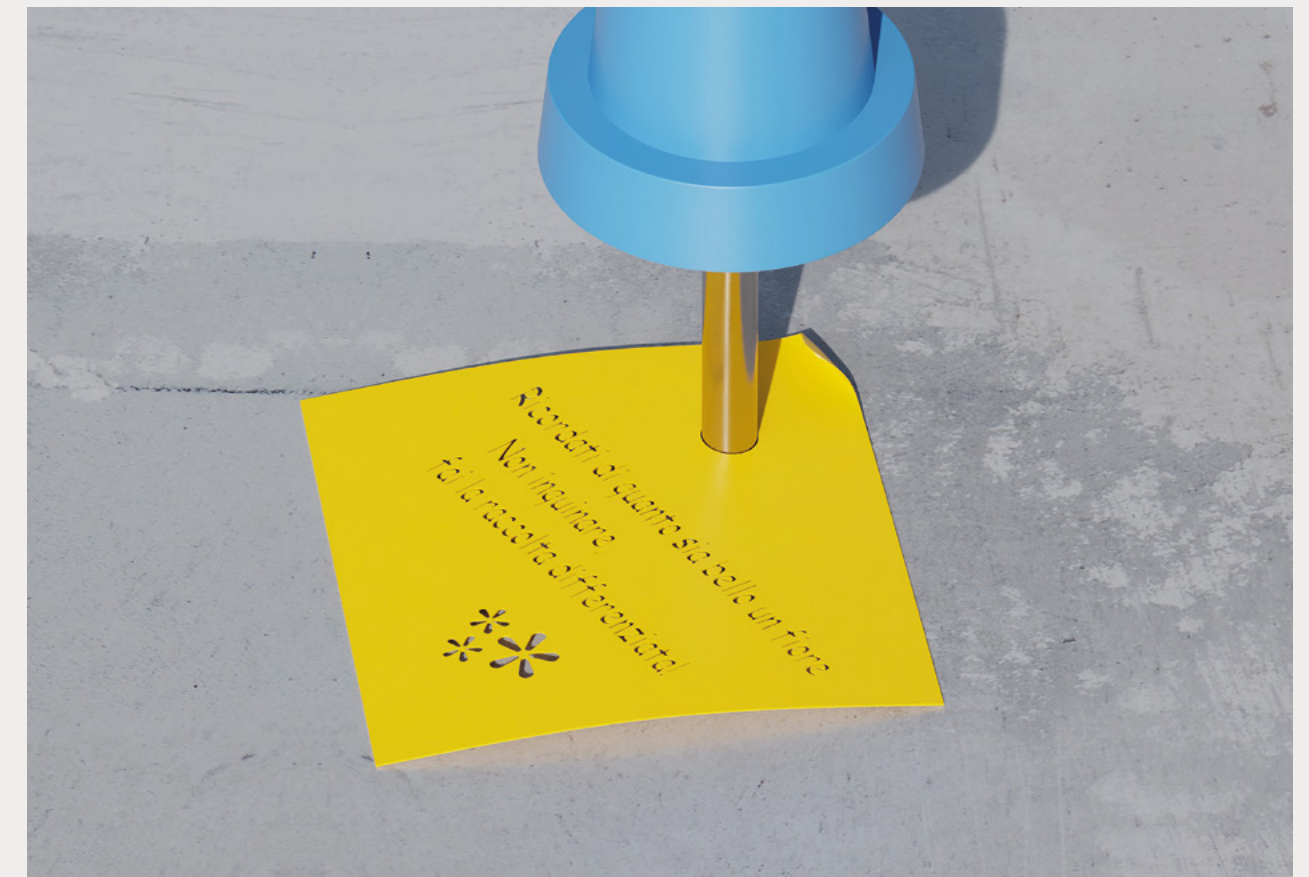

Post-It

D867-P

PANNELLO / PANEL

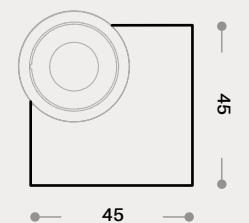

Designer	Dimcar Design Department
Dimensioni / Sizes	45x45 cm - 3 Kg
Materiali / Materials	Acciaio zincato / Galvanized steel
Fissaggio / Fixing	Predisposizione per tasselli / Predisposition for dowels
Plus / Plus	Messaggio personalizzabile / Customizable message

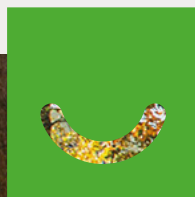

S-It

D868

SEDUTA / SEAT

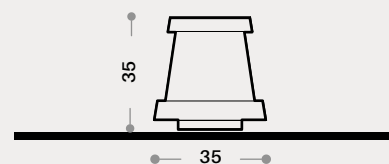

Designer	Dimcar Design Department
Dimensioni / Sizes	35x35 cm H 35 cm - 8 kg
Materiali / Materials	Acciaio zincato / Galvanized steel
Fissaggio / Fixing	Predisposizione per tasselli / Predisposition for dowels



YoYo

D858

PORTABICICI / BIKE RACK

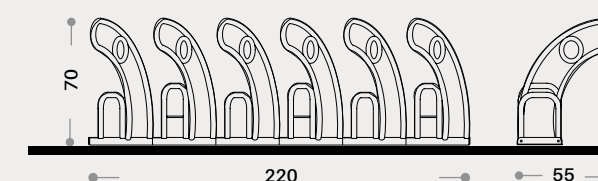
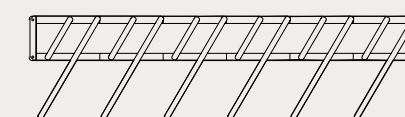

Designer	Dimcar Design Department
Dimensioni / Sizes	220x55 cm H 70 cm - 34 kg
N. posti / No. spaces	6
Materiali / Materials	Acciaio zincato / Galvanized steel
Fissaggio / Fixing	Predisposizione per tasselli / Predisposition for dowels





Adelina la lumachina

G549

CESTINO / LITTER BIN



Lauretta la ranetta

G552

CESTINO / LITTER BIN

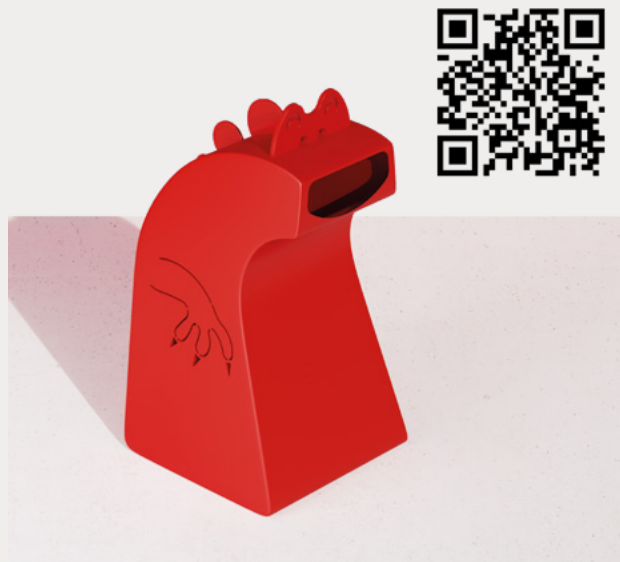

Mauro il dinosauro

G551

CESTINO / LITTER BIN

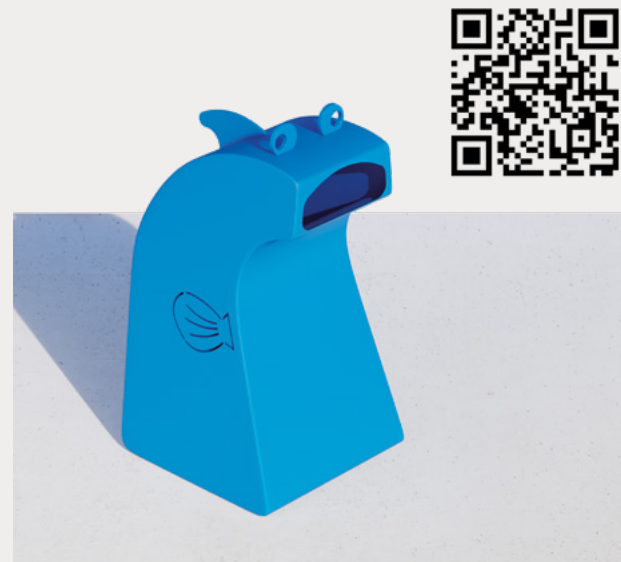

Nino il pesciolino

G548

CESTINO / LITTER BIN

Designer Gibillero Design

Materiali / Materials Acciaio zincato / Galvanized steel

Fissaggio / Fixing Predisposizione per tasselli / Predisposition for dowels

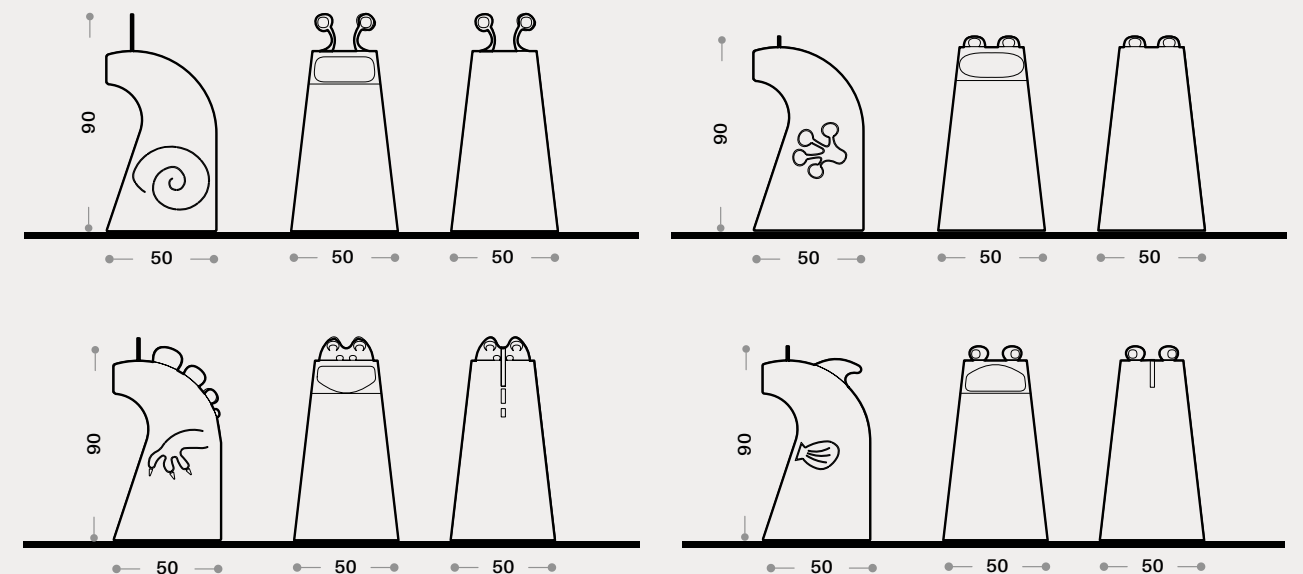



Formaggino

G560

CESTINO / LITTER BIN

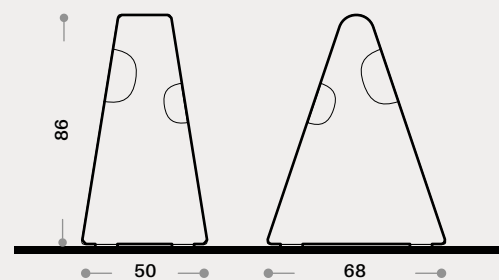

Designer	Gibillero Design
Dimensioni / Sizes	68x50cm H 86 cm - 25 lt - 34 kg
Materiali / Materials	Acciaio zincato / Galvanized steel
Fissaggio / Fixing	Predisposizione per tasselli / Predisposition for dowels

Temperarifiuti

D872

CESTINO / LITTER BIN

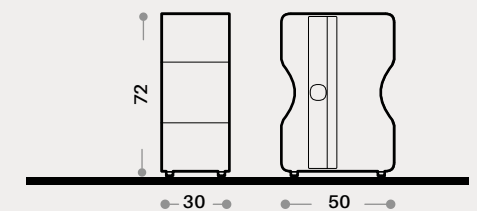

Designer	Dimcar Design Department
Dimensioni / Sizes	50x30cm H 72 cm - 31 kg
Materiali / Materials	Acciaio zincato / Galvanized steel
Fissaggio / Fixing	Predisposizione per tasselli / Predisposition for dowels



NEL CUORE DELL'AZIENDA, IN
CUI IL METALLO INCONTRA
L'INGEGNO, L'ACCIAIO SI FA
LUCE, PRONTO A ILLUMINARE
IL VOLTO DELLE CITTÀ.

*THE COMPANY'S CORE IS WHERE METAL MEETS
INGENUITY, AND STEEL BECOMES LIGHT, READY
TO ILLUMINATE CITIES' FACES.*

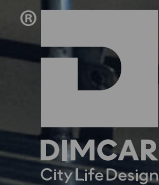

PROTEGGI I CITTADINI
E VALORIZZA I PUNTI
DI ATTESA CON DESIGN
FUNZIONALE E RESISTENTE.



*PROTECT CITIZENS AND ENHANCE WAITING
AREAS WITH FUNCTIONAL AND DURABLE
DESIGN.*



PENSILINE,
CICLOSTAZIONI E
COPERTURE

*BUS SHELTERS,
BIKE STATIONS AND
CANOPIES*



INDEX

PENSILINE, CICLOSTAZIONI E COPERTURE BUS SHELTERS, BIKE STATIONS AND CANOPIES



231-BIS
pag. 114



447-BIS
pag. 116



448-BIS
pag. 118



G522
pag. 120



G524
pag. 122



368
pag. 124



D863
pag. 126



816
pag. 128



D862
pag. 130



810
pag. 132



Acaya

231-BIS

CON PARETI LATERALI /
WITH SIDE WALLS



Designer Dimcar Design Department

Dimensioni / Sizes 319x204 cm H 245 cm - 306 kg

Materiali / Materials Acciaio zincato, Policarbonato alveolare trasparente, Policarbonato alveolare opaco / Galvanized steel, Transparent polycarbonate honeycomb, Tinted polycarbonate honeycomb

Fissaggio / Fixing Ancoraggio chimico / Chemical anchoring

Optionals / Optionals Illuminazione / Lighting

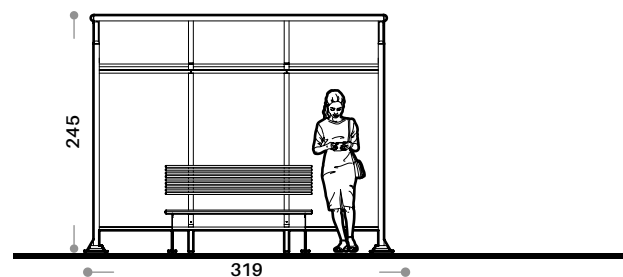
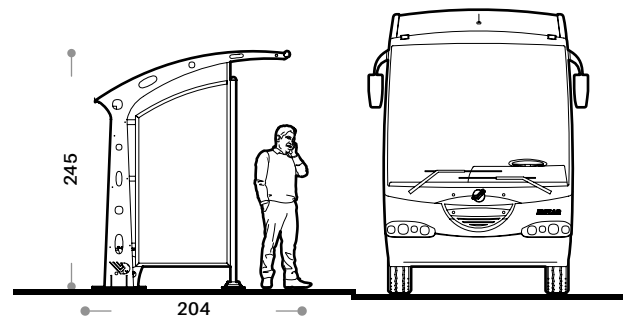



Alessandra

447-BIS

CON PARETI LATERALI /
WITH SIDE WALLS

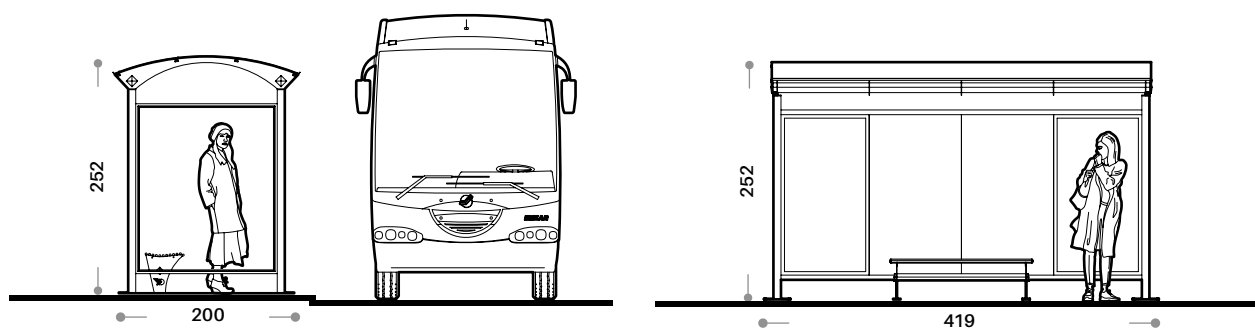

Designer Arch. Stefano Montagner

Dimensioni / Sizes 419x200 cm H 252 cm - 486 kg

Materiali / Materials Acciaio zincato, Policarbonato compatto Fumè, Vetro stratificato /
Galvanized steel, Tinted compact polycarbonate, Laminated glass

Fissaggio / Fixing Ancoraggio chimico / Chemical anchoring

Optionals / Optionals Illuminazione / Lighting





Carlotta

448-BIS

AUTOPORTANTE /
SELF-SUPPORTING

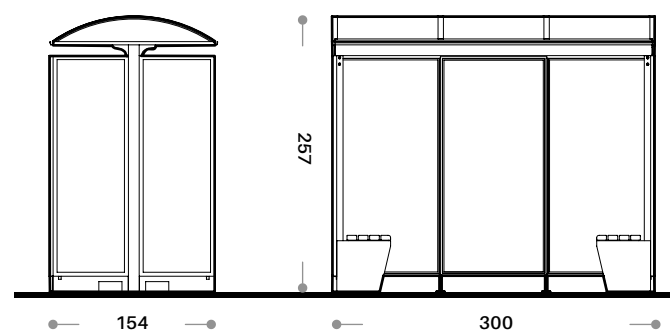

Designer	Arch. Stefano Montagner
Dimensioni / Sizes	300x154 cm H 257 cm - 1916 kg
Materiali / Materials	Vetro stratificato, Cemento bianco liscio, Acciaio Zincato, Policarbonato alveolare opaco / Laminated glass, White smooth concrete, Galvanized Steel, Matt polycarbonate honeycomb
Fissaggio / Fixing	Autoportante / Self-supporting
Optionals / Optionals	Illuminazione / Lighting





Plaza

G522

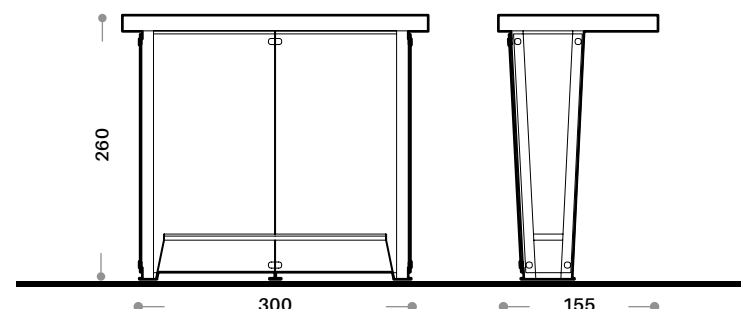

Designer	Gibillero Design
Dimensioni / Sizes	300x155 cm H 260 cm - 519 kg
Materiali / Materials	Acciaio Zincato, Vetro stratificato / Galvanized Steel, Laminated glass
Fissaggio / Fixing	Predisposizione per zanche / By means of metal clamps
Plus / Plus	Illuminazione / Lighting





Robin

G524

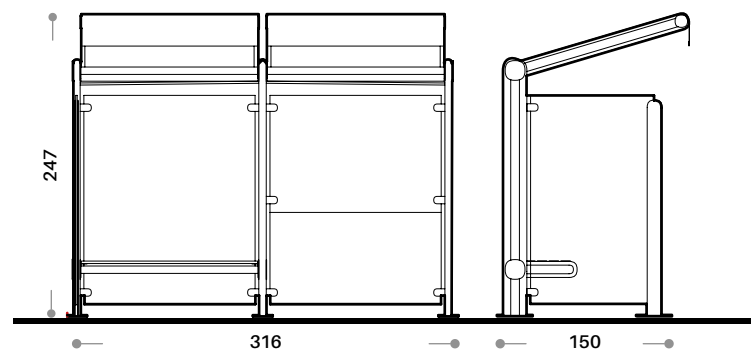

Designer	Gibillero Design
Dimensioni / Sizes	316x150 cm H 247 cm - 566 kg
Materiali / Materials	Acciaio Zincato, Policarbonato compatto trasparente, Vetro stratificato, Listoni in legno / Galvanized Steel, Transparent compact polycarbonate, Laminated glass, Wooden planks
Fissaggio / Fixing	Predisposizione per zanche / By means of metal clamps
Optional / Optional	Illuminazione / Lighting





Space

368

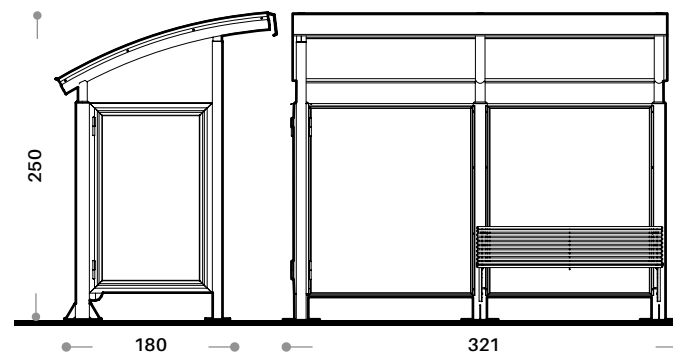

Designer	Dimcar Design Department
Dimensioni / Sizes	321x180 cm H 250 cm - 485 kg
Materiali / Materials	Acciaio Zincato, Policarbonato compatto fumè, Vetro stratificato / Galvanized Steel, Tinted compact Polycarbonate, Laminated glass
Fissaggio / Fixing	Ancoraggio chimico / Chemical anchoring
Plus / Plus	Bacheca illuminata / Illuminated bulletin board
Optional / Optional	Illuminazione / Lighting





Arles copertura auto

D863

ARLES CARPORT



Moduli/
modules

M1	M2	M3	M4	...	M11
Min					Max

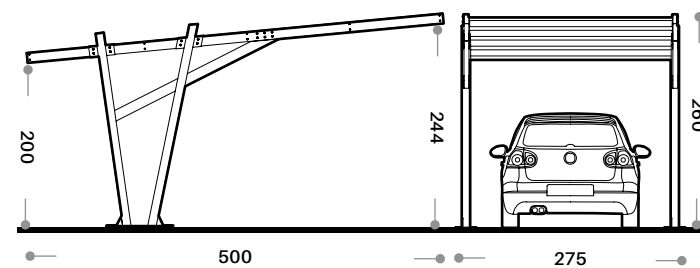

Designer	Dimcar Design Department
Dimensioni / Sizes	500x275 cm H 260 cm - 355 kg
N° posti auto / N° parking space 1	
Materiali / Materials	Acciaio zincato / Galvanized steel
Fissaggio / Fixing	Predisposizione per zanche / By means of metal clamps





Living

816

LIVING CANOPY

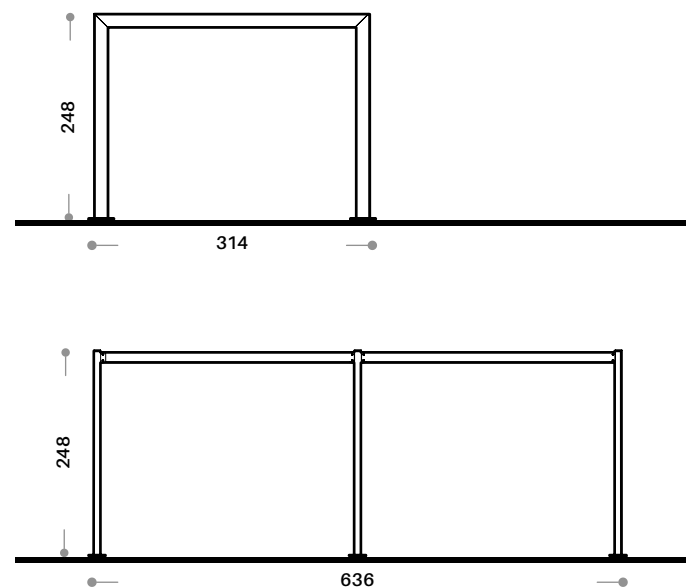

Designer	Dimcar Design Department
Dimensioni / Sizes	636x314 cm H 248 cm - 642 kg
Materiali / Materials	Acciaio zincato / Galvanized steel
Fissaggio / Fixing	Ancoraggio chimico / Chemical anchoring
Optional / Optional	Telo in pvc, Telo ombreggiante, Cavi in alluminio / Pvc cloth, Shade cloth, Aluminium cables





Young

D862

YOUNG CANOPY

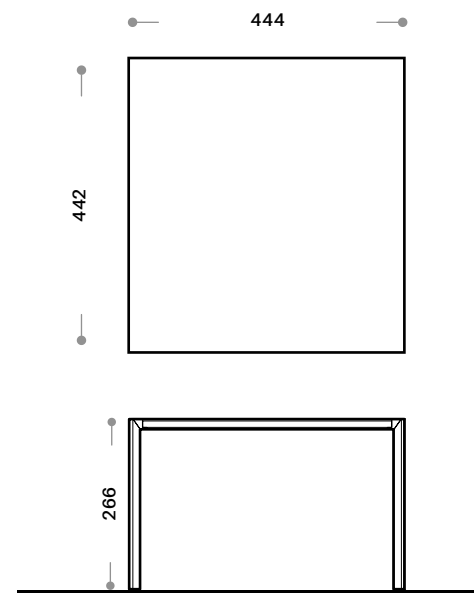

Designer	Dimcar Design Department
Dimensioni / Sizes	442x444 cm H 266 cm - 534 kg
Materiali / Materials	Acciaio zincato / Galvanized steel
Fissaggio / Fixing	Ancoraggio chimico / Chemical anchoring





Maranello ciclostazione

810

MARANELLO BIKE STATION

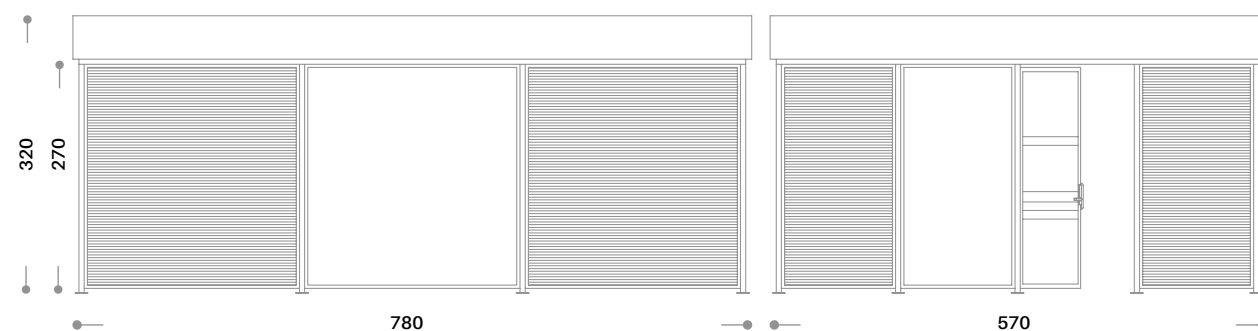

Designer	Dimcar Design Department
Dimensioni / Sizes	780x570 cm H 320 cm
Materiali / Materials	Acciaio Zincato, Vetro stratificato / Galvanized Steel, Laminated glass
Fissaggio / Fixing	Ancoraggio chimico / Chemical anchoring
Optionals / Optionals	Illuminazione / Lighting





CREARE NON È SOLO FARE.
È ASCOLTARE CIÒ CHE
ANCORA NON C'È E
PORTARLO ALLA LUCE.

*CREATING IS MORE THAN JUST DOING.
IT'S IMPORTANT TO LISTEN TO WHAT'S NOT YET
VISIBLE AND SEED IT INTO THE LIGHT.*

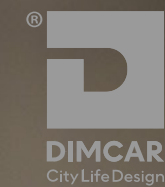

OTTIMIZZA GLI SPAZI URBANI
CON SOLUZIONI PRATICHE
PER PARCHEGGIARE LE BICI.

*OPTIMIZE URBAN SPACES WITH PRACTICAL
SOLUTIONS FOR BIKE PARKING.*



PORTABICI BIKE RACKS



Portabici
Bike racks



INDEX

RASTRELLIERE PORTABICI BIKE RACKS



605

pag. 140



613

pag. 142



615

pag. 143



286

pag. 144



386

pag. 146



386-bis

pag. 147



G491

pag. 148

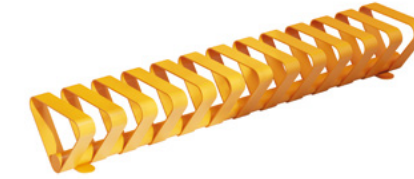

G496

pag. 149

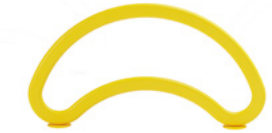

G513

pag. pag. 150



G494

pag. 151

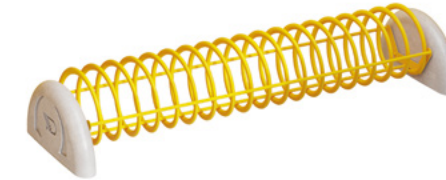

414

pag. 152



D879

pag. 153

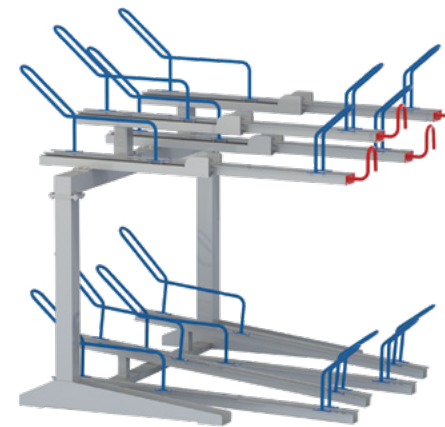

911

pag. 154



190

pag. 155





Bucatinino

605

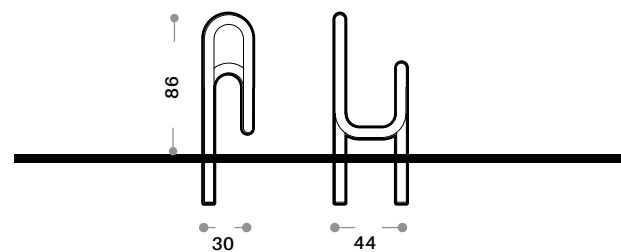

Designer	Dimcar Design Department
Dimensioni / Sizes	44x30 cm H 86 cm - 12 kg
N° posto bici / N° bike space	2
Materiali / Materials	Acciaio zincato / Galvanized steel
Fissaggio / Fixing	Cementazione / Cementation





Elica

613

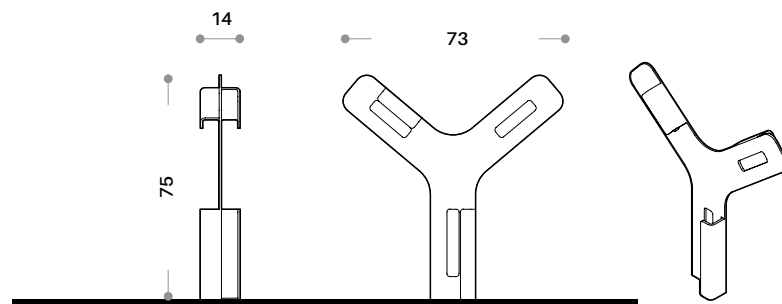

Designer	Dimcar Design Department
Dimensioni / Sizes	73x14 cm H 75 cm - 17 kg
N° posto bici / N° bike space	2
Materiali / Materials	Acciaio zincato / Galvanized steel
Fissaggio / Fixing	Predisposizione per tasselli / Predisposition for dowels



Rio con presa di ricarica

615

RIO BIKE RACK WITH CHARGING SOCKET

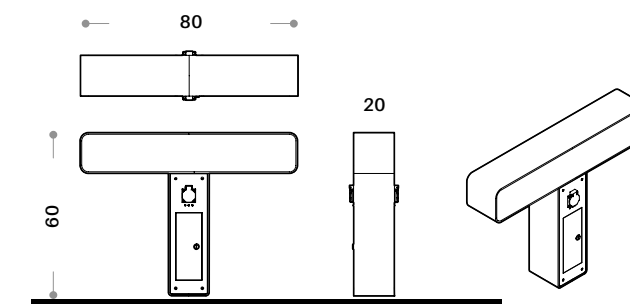

Designer	Dimcar Design Department
Dimensioni / Sizes	80x20 cm H 60 cm - 25 kg
N° posto bici / N° bike space	2
Materiali / Materials	Acciaio zincato / Galvanized steel
Fissaggio / Fixing	Predisposizione per tasselli / Predisposition for dowels





Liberty

286

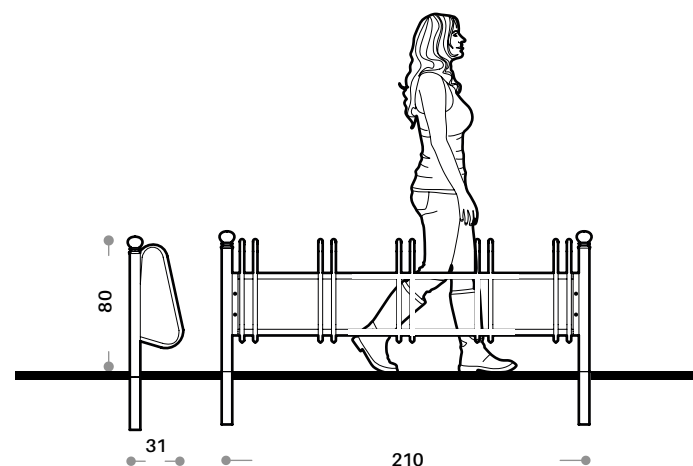

Designer Dimcar Design Department

Dimensioni / Sizes 210x31 cm H 80 cm - 22 kg

N° posto bici / N° bike space 5

Materiali / Materials Acciaio zincato / Galvanized steel

Fissaggio / Fixing Cementazione / Cementation





Milano

386

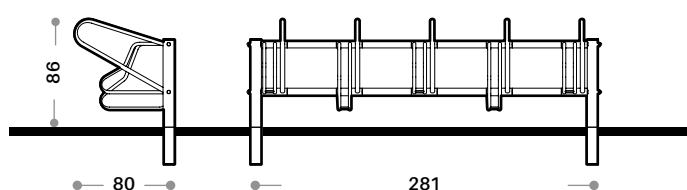

Designer	Dimcar Design Department
Dimensioni / Sizes	281x80 cm H 86 cm - 59 kg
N° posto bici / N° bike space	5
Materiali / Materials	Acciaio zincato / Galvanized steel
Fissaggio / Fixing	Cementazione / Cementation



Milano bifacciale

386-BIS

MILANO DOUBLE-SIDED BIKE RACK

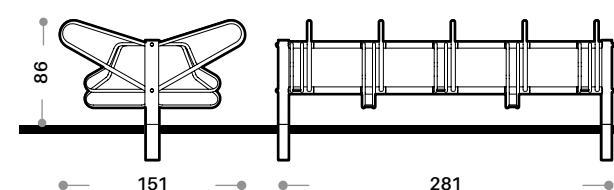

Designer	Dimcar Design Department
Dimensioni / Sizes	281x151 cm H 86 cm - 90 kg
N° posto bici / N° bike space	10
Materiali / Materials	Acciaio zincato / Galvanized steel
Fissaggio / Fixing	Cementazione / Cementation



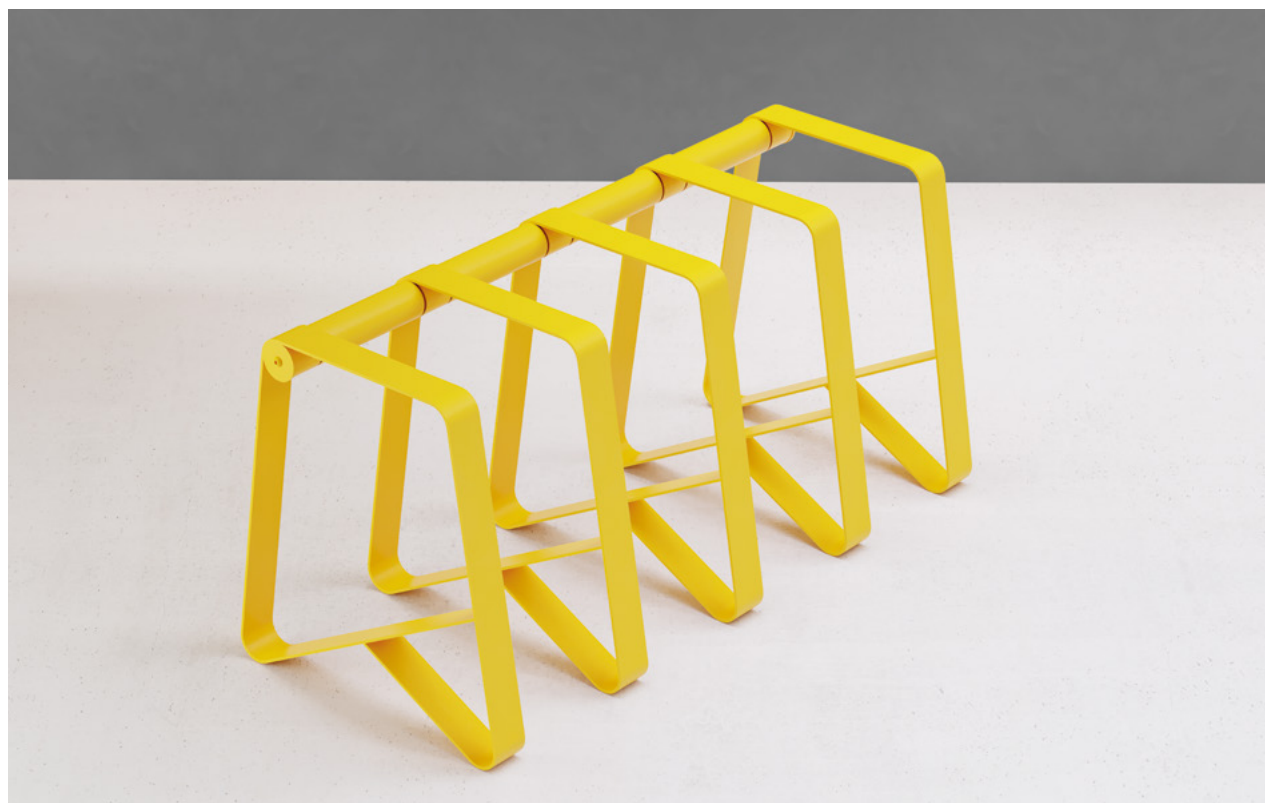

Bel

G491

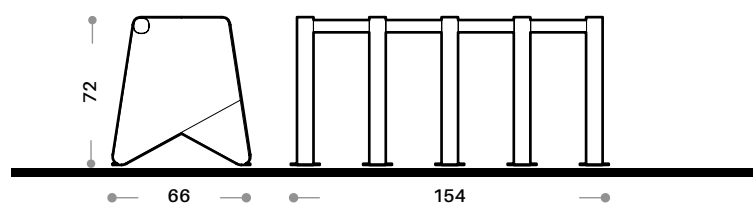

Designer	Gibillero Design
Dimensioni / Sizes	154x66 cm H 72 cm - 63 kg
N° posto bici / N° bike space	5
Materiali / Materials	Acciaio zincato / Galvanized steel
Fissaggio / Fixing	Predisposizione per tasselli / Predisposition for dowels



Tresette

G496

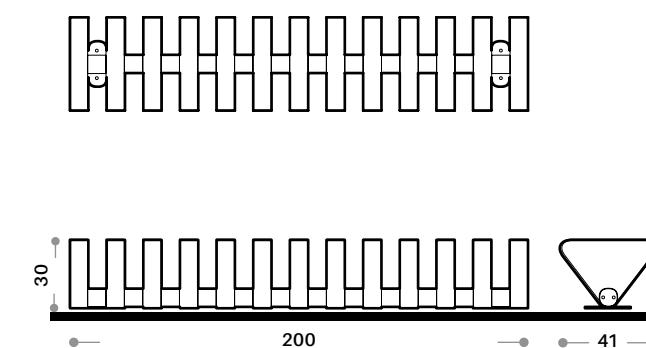

Designer	Gibillero Design
Dimensioni / Sizes	200x41 cm H 30 cm - 62 kg
N° posto bici / N° bike space	8
Materiali / Materials	Acciaio zincato / Galvanized steel
Fissaggio / Fixing	Predisposizione per tasselli / Predisposition for dowels





Bean

G513

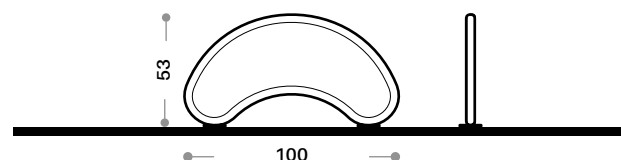

Designer	Gibillero Design
Dimensioni / Sizes	100x10 cm H 53 cm - 5 kg
N° posto bici / N° bike space	2
Materiali / Materials	Acciaio zincato / Galvanized steel
Fissaggio / Fixing	Predisposizione per tasselli / Predisposition for dowels



Tatou

G494

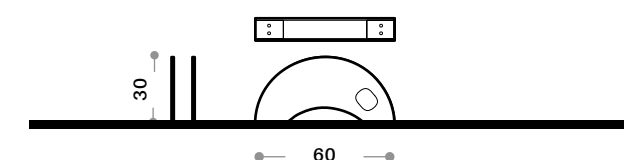

Designer	Gibillero Design
Dimensioni / Sizes	60x10 cm H 30 cm - 14 kg
N° posto bici / N° bike space	1
Materiali / Materials	Acciaio zincato / Galvanized steel
Fissaggio / Fixing	Predisposizione per tasselli / Predisposition for dowels



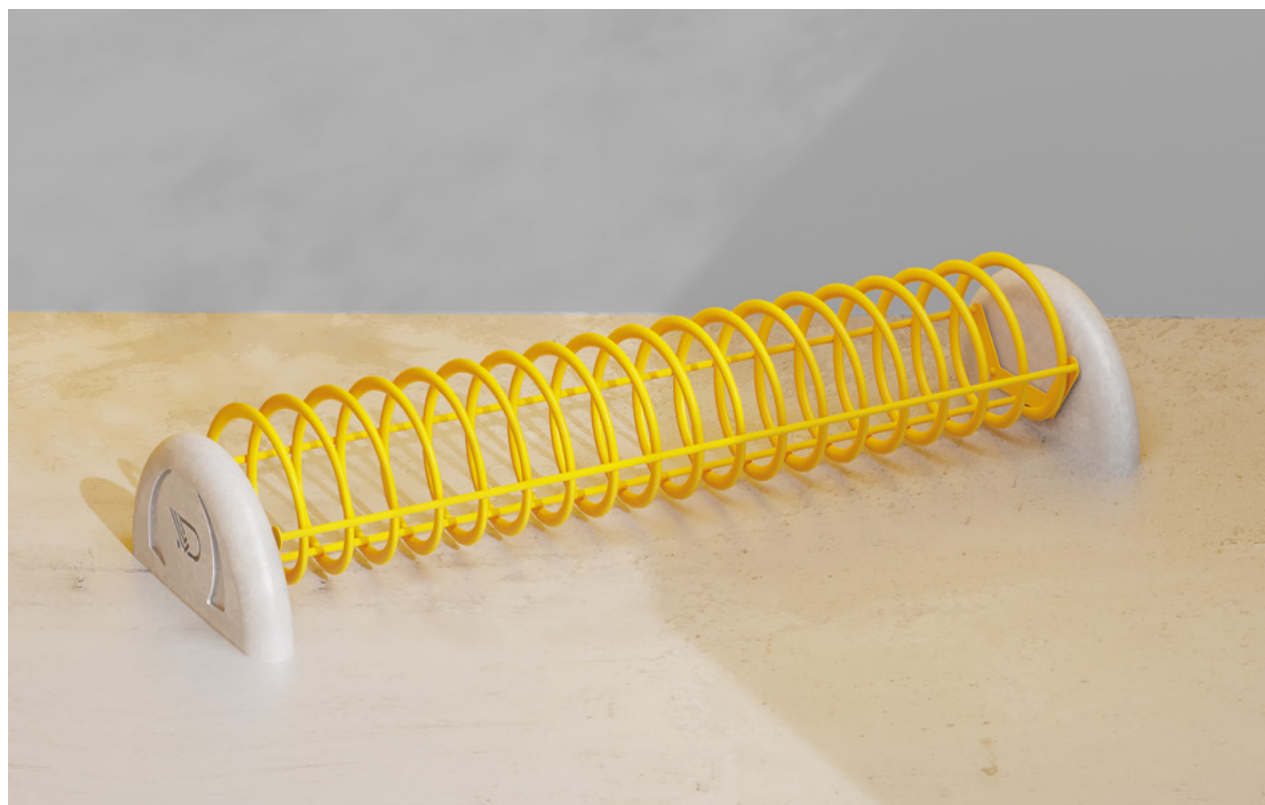

Spiro

414

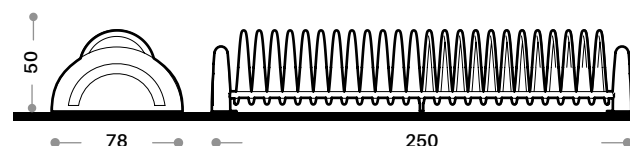

Designer	Dimcar Design Department
Dimensioni / Sizes	250x78 cm H 50 cm - 174 kg
N° posto bici / N° bike space	10
Materiali / Materials	Acciaio zincato, Cemento bianco liscio / Galvanized steel, White smooth concrete
Fissaggio / Fixing	Predisposizione per tasselli, Autoportante / Predisposition for dowels, Self supporting



Plomb

D879

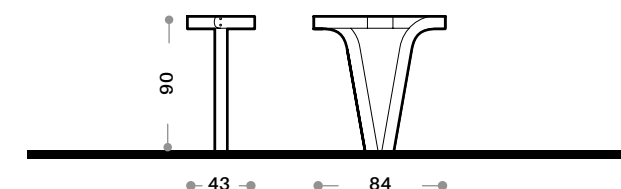

Designer	Dimcar Design Department
Dimensioni / Sizes	84x43 cm H 90 cm - 18 kg
N° posto bici / N° bike space	2
Materiali / Materials	Acciaio zincato / Galvanized steel
Fissaggio / Fixing	Predisposizione per tasselli / Predisposition for dowels



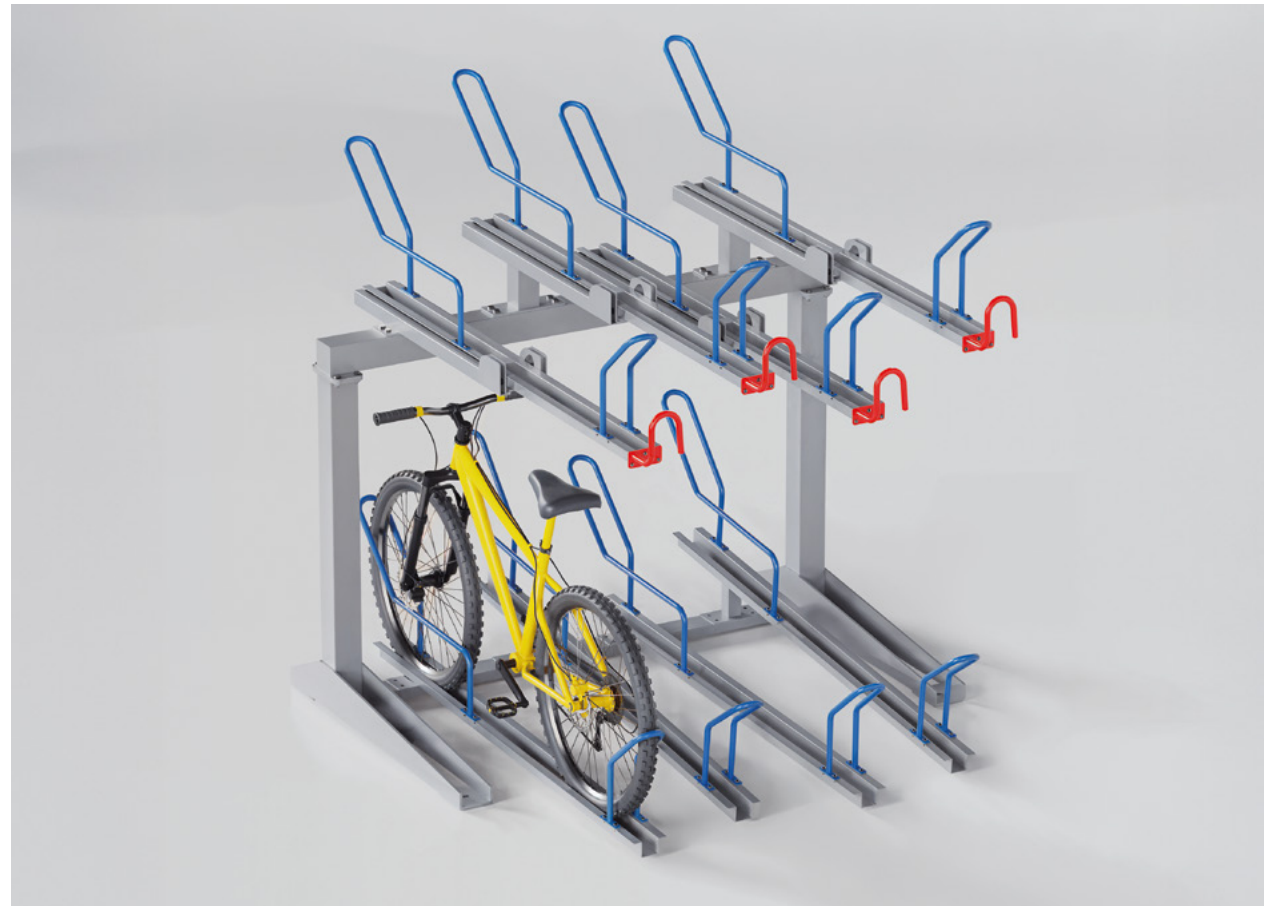

Tandem

911

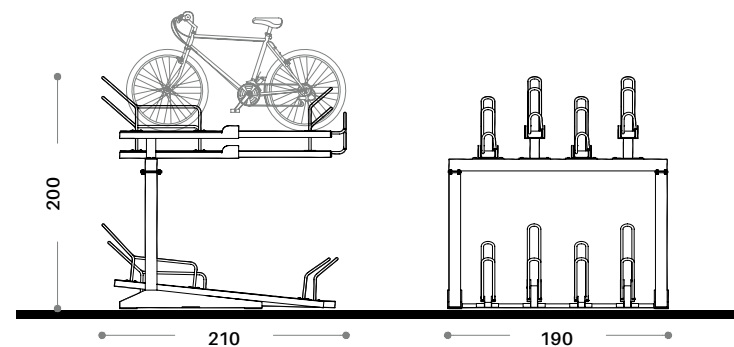

Designer	Dimcar Design Department
Dimensioni / Sizes	190x210 cm H 200 cm - 280 kg
N° posto bici / N° bike space	8
Materiali / Materials	Acciaio zincato / Galvanized steel
Fissaggio / Fixing	Predisposizione per tasselli / Predisposition for dowels



Ciclo Park

190

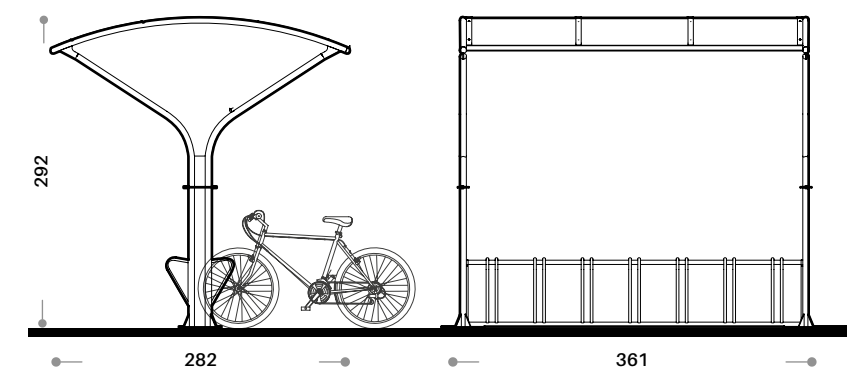

Designer	Dimcar Design Department
Dimensioni / Sizes	361x282 cm H 292 cm - 267 kg
N° posto bici / N° bike space	14
Materiali / Materials	Acciaio zincato, Policarbonato alveolare opaco / Stainless Steel, Matt polycarbonate honeycomb
Fissaggio / Fixing	Predisposizione per zanche / By means of metal clamps

OFFRI COMFORT E STILE PER
IL RELAX DI CITTADINI E
TURISTI.



*OFFER COMFORT AND STYLE FOR THE
RELAXATION OF CITIZENS AND TOURISTS.*



PANCHINE E PANCHE DA ESTERNO

*OUTDOOR BENCHES
AND SEATINGS*



INDEX

PANCHINE DA ESTERNO OUTDOOR BENCHES



298-D-V
pag.162



298-V
pag.164



298-BIS-V
pag.165



1137
pag.166



1137-I
pag.167



G534
pag.168



G535
pag.169



G454
pag.170



G461
pag.171



400-OK
pag.172



1133
pag.173



G519
pag.174



1121-BIS
pag.176



G471
pag.177



G467
pag.178



G545
pag.179



INDEX

PANCHINE DA ESTERNO OUTDOOR SEATINGS



603
pag.180



297
pag.182



486-P
pag.183



401-ok
pag.183



451
pag.184



356
pag.185



D883
pag.186



G470
pag.187



D814
pag.188



D813
pag.189





Clematis

298-D-V

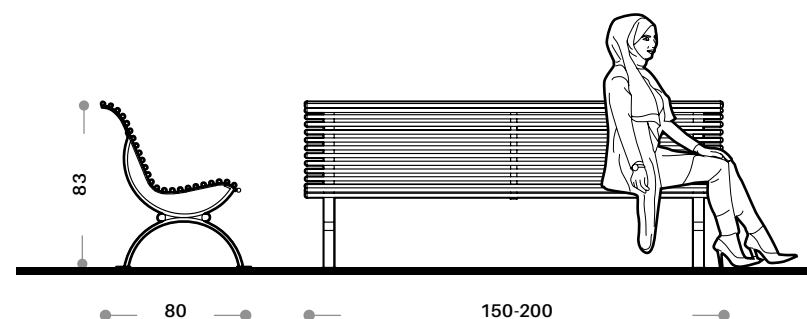

Designer	Dimcar Design Department
Dimensioni / Sizes	150-200x80 cm H 83 cm - 55 kg
N. posti / No. of seats	3-4
Materiali / Materials	Acciaio zincato / Galvanized steel
Fissaggio / Fixing	Predisposizione per tasselli / Predisposition for dowels





Clematis

298-V

PANCHINA SEDUTA LATO CONCAVO/
CLEMATIS BENCH CONCAVE SIDE
SITTING



Disposizioni/
Layout

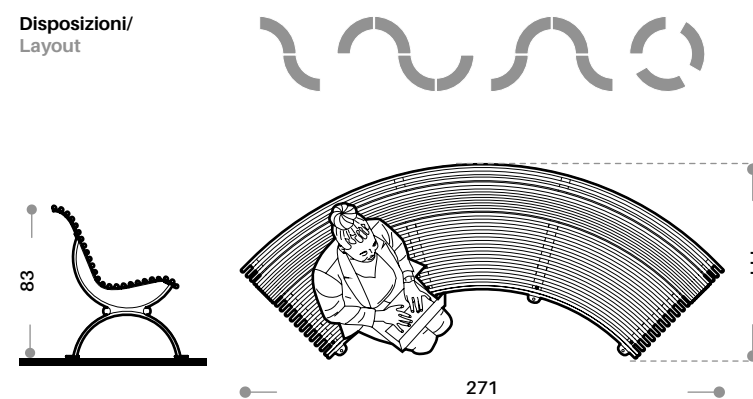

Designer	Dimcar Design Department
Dimensioni / Sizes	271x111 cm H 83 cm - 87 kg
N. posti / No. of seats	4
Materiali / Materials	Acciaio zincato / Galvanized steel
Fissaggio / Fixing	Predisposizione per tasselli / Predisposition for dowels



Clematis

298-BIS-V

PANCHINA SEDUTA LATO
CONVESSO / CLEMATIS BENCH
CONVEX SIDE SITTING



Disposizioni/
Layout

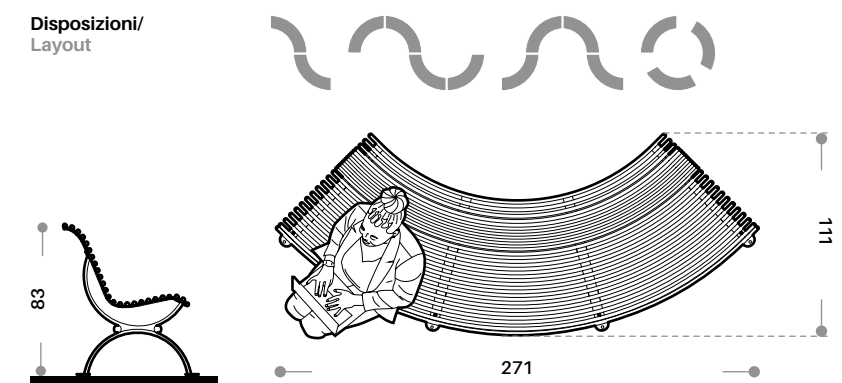

Designer	Dimcar Design Department
Dimensioni / Sizes	271x111 cm H 83 cm - 87 kg
N. posti / No. of seats	4
Materiali / Materials	Acciaio zincato / Galvanized steel
Fissaggio / Fixing	Predisposizione per tasselli / Predisposition for dowels



Teulada

1137

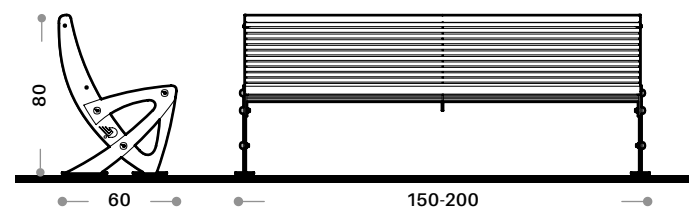

Designer	Dimcar Design Department
Dimensioni / Sizes	150-200x60 cm H 80 cm - 65 kg
N. posti / No. of seats	3-4
Materiali / Materials	Acciaio zincato / Galvanized steel
Fissaggio / Fixing	Predisposizione per tasselli / Predisposition for dowels



Teulada

1137-I

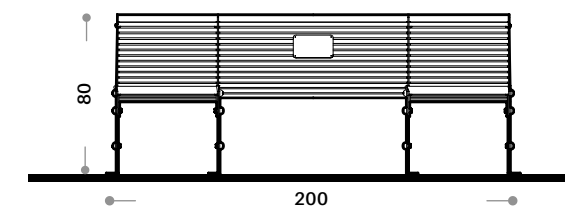

Designer	Dimcar Design Department
Dimensioni / Sizes	200x60 cm H 80 cm - 81 kg
N. posti / No. of seats	3
Materiali / Materials	Acciaio zincato / Galvanized steel
Fissaggio / Fixing	Predisposizione per tasselli / Predisposition for dowels



Betty

G534

PANCHINA CON BRACCIOLI /
BENCH WITH ARMRESTS

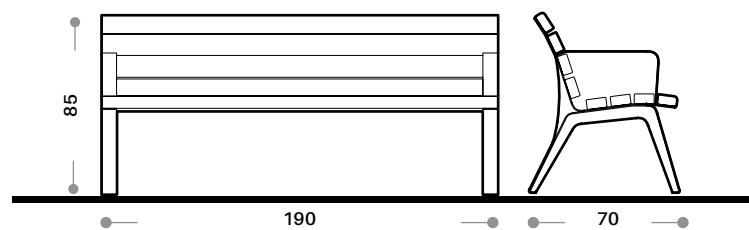

Designer	Gibillero Design
Dimensioni / Sizes	190x70 cm H 85 cm - 54 kg
N. posti / No. of seats	3
Materiali / Materials	Acciaio zincato, Listoni in legno / Galvanized steel, Wooden planks
Fissaggio / Fixing	Predisposizione per tasselli / Predisposition for dowels



Betty

G535

PANCHINA SENZA BRACCIOLI /
BENCH WITHOUT ARMRESTS



Designer	Gibillero Design
Dimensioni / Sizes	190x70 cm H 85 cm - 50 kg
N. posti / No. of seats	3
Materiali / Materials	Acciaio zincato, Listoni in legno / Galvanized steel, Wooden planks
Fissaggio / Fixing	Predisposizione per tasselli / Predisposition for dowels



Ace

G454

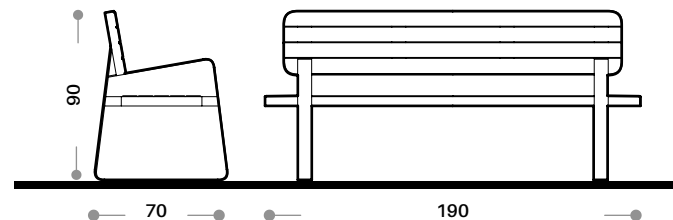

Designer	Gibillero Design
Dimensioni / Sizes	190x70 cm H 90 cm - 67 kg
N. posti / No. of seats	3
Materiali / Materials	Acciaio zincato, Listoni in legno / Galvanized steel, Wooden planks
Fissaggio / Fixing	Predisposizione per tasselli / Predisposition for dowels



Cross

G461

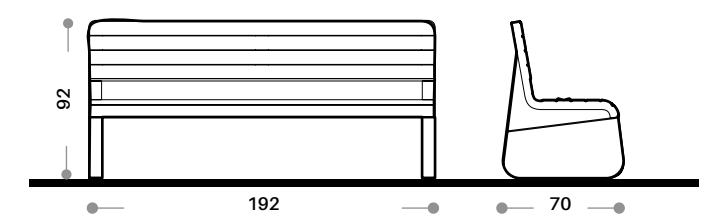

Designer	Gibillero Design
Dimensioni / Sizes	192x70 cm H 92 cm - 65 kg
N. posti / No. of seats	4
Materiali / Materials	Acciaio zincato, Listoni in legno / Galvanized steel, Wooden planks
Fissaggio / Fixing	Predisposizione per tasselli / Predisposition for dowels



Essenza

400-OK

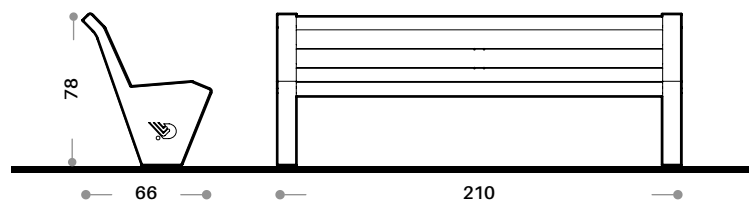

Designer	Dimcar Design Department
Dimensioni / Sizes	210x66 cm H 78 cm - 69 kg
N. posti / No. of seats	4
Materiali / Materials	Acciaio zincato, Listoni in legno / Galvanized steel, Wooden planks
Fissaggio / Fixing	Predisposizione per tasselli / Predisposition for dowels



Luxe

1133

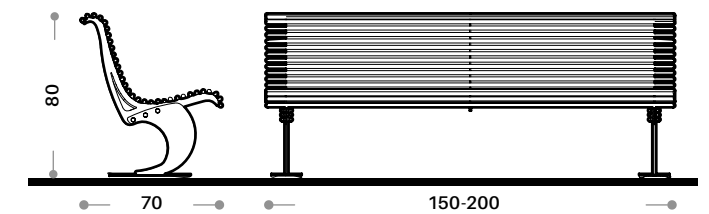

Designer	Dimcar Design Department
Dimensioni / Sizes	150-200x70 cm H 80 cm - 66 kg
N. posti / No. of seats	3-4
Materiali / Materials	Acciaio inox / Stainless steel
Fissaggio / Fixing	Predisposizione per tasselli / Predisposition for dowels



Flea

G519

PANCHINA SEDUTA DOPPIA /
FLEA DOUBLE SEAT BENCH

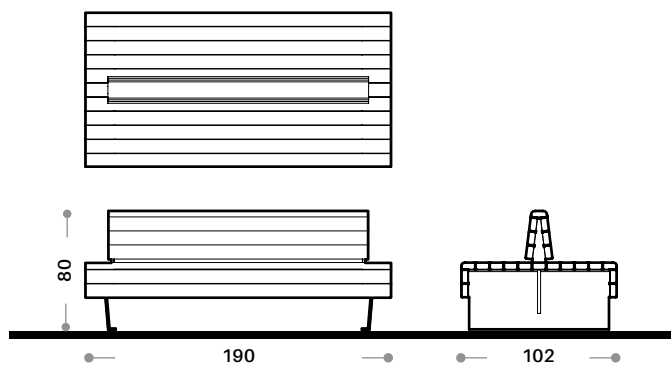

Designer	Gibillero Design
Dimensioni / Sizes	190x102 cm H 80 cm - 166 kg
N. posti / No. of seats	8
Materiali / Materials	Acciaio zincato, Listoni in legno / Galvanized steel, Wooden planks
Fissaggio / Fixing	Predisposizione per tasselli / Predisposition for dowels





Lesina

1121-BIS

PANCHINA CON BRACCIOLI /
BENCH WITH ARMRESTS

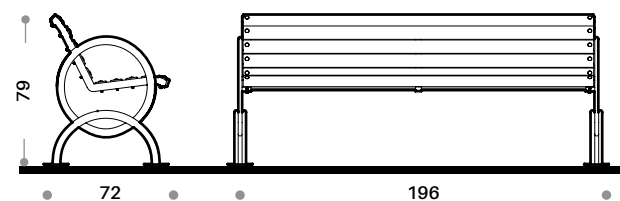

Designer	Dimcar Design Department
Dimensioni / Sizes	196x72 cm H 79 cm - 47 kg
N. posti / No. of seats	4
Materiali / Materials	Acciaio zincato, Listoni in legno / Galvanized steel, Wooden planks
Fissaggio / Fixing	Predisposizione per tasselli / Predisposition for dowels



Record

G471

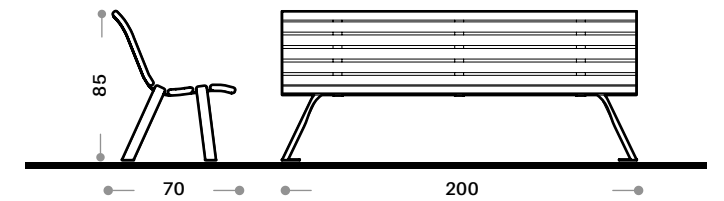

Designer	Gibillero Design
Dimensioni / Sizes	200x70 cm H 85 cm - 53 kg
N. posti / No. of seats	4
Materiali / Materials	Acciaio zincato / Galvanized steel
Fissaggio / Fixing	Predisposizione per tasselli / Predisposition for dowels



Eddie

G467

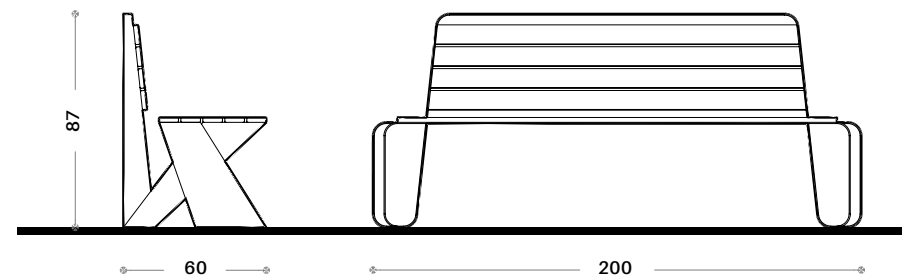

Designer	Gibillero Design
Dimensioni / Sizes	200x60 cm H 87 cm - 90 kg
N. posti / No. of seats	4
Materiali / Materials	Acciaio zincato, Listoni in legno / Galvanized steel, Wooden planks
Fissaggio / Fixing	Predisposizione per tasselli / Predisposition for dowels



Portland

G545

SEDUTA CON SCHIENALE /
SEAT WITH BACKREST

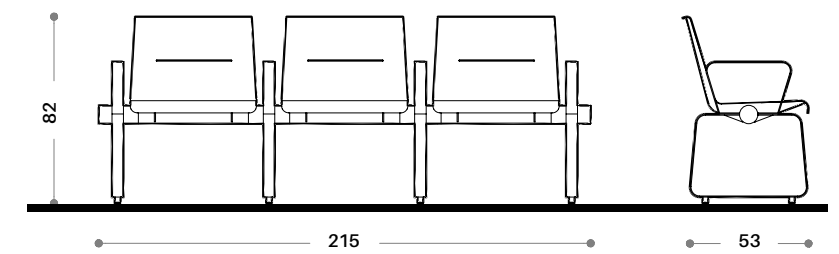

Designer	Gibillero Design
Dimensioni / Sizes	215x53 cm H 82 cm - 77 kg
N. posti / No. of seats	3
Materiali / Materials	Acciaio zincato / Galvanized steel
Fissaggio / Fixing	Predisposizione per tasselli / Predisposition for dowels



Hello

603

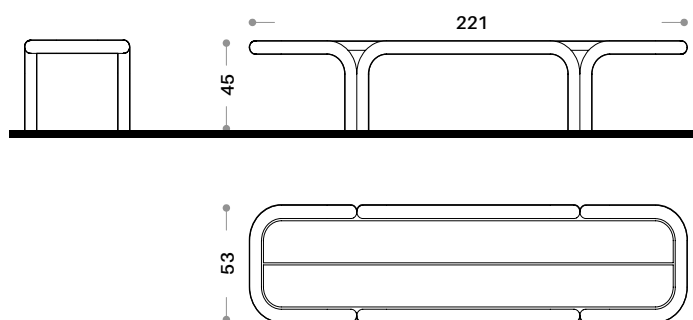

Designer	Dimcar Design Department
Dimensioni / Sizes	221x53 cm H 45 cm - 26 kg
Materiali / Materials	Acciaio zincato, Listoni in legno / Galvanized steel, Wooden planks
Fissaggio / Fixing	Predisposizione per tasselli / Predisposition for dowels





Siris

297

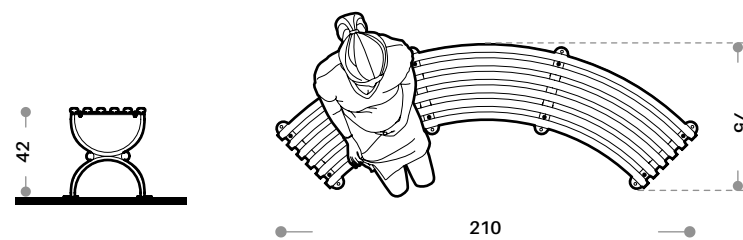

Designer	Dimcar Design Department
Dimensioni / Sizes	210x75cm H 42 cm - 51 kg
N. posti / No. of seats	4
Materiali / Materials	Acciaio zincato / Galvanized steel
Fissaggio / Fixing	Predisposizione per tasselli / Predisposition for dowels



Clematis

486-P

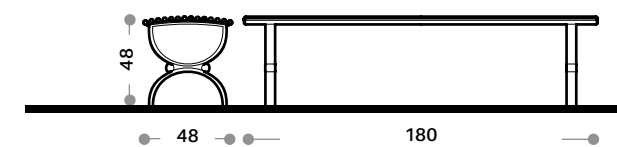

Designer	Dimcar Design Department
Dimensioni / Sizes	180x48 cm H 48 cm - 35 kg
N. posti / No. of seats	3
Materiali / Materials	Acciaio zincato / Galvanized steel
Fissaggio / Fixing	Predisposizione per tasselli / Predisposition for dowels



Essenza

401-OK

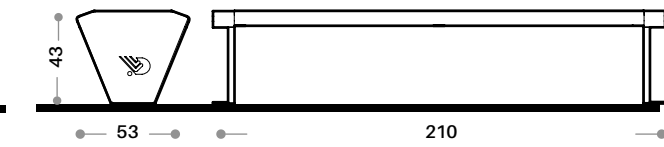

Designer	Dimcar Design Department
Dimensioni / Sizes	210x53 cm H 43 cm - 44 kg
N. posti / No. of seats	4
Materiali / Materials	Acciaio zincato, Listoni in legno / Galvanized steel, Wooden planks
Fissaggio / Fixing	Predisposizione per tasselli / Predisposition for dowels



Iccos

451



Designer	Dimcar Design Department
Dimensioni / Sizes	236x43 cm H 46 cm - 66 kg
N. posti / No. of seats	4
Materiali / Materials	Acciaio zincato, Listoni in legno / <i>Galvanized steel, Wooden planks</i>
Fissaggio / Fixing	Predisposizione per tasselli / <i>Predisposition for dowels</i>



Rubix

356

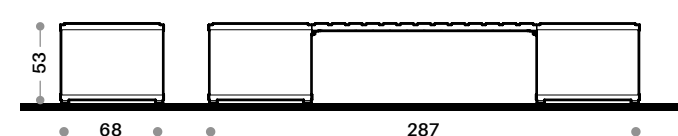

Designer	Dimcar Design Department
Dimensioni / Sizes	287x68cm H 53 cm - 94 kg
N. posti / No. of seats	3
Materiali / Materials	Acciaio zincato, Listoni in legno / <i>Galvanized steel, Wooden planks</i>
Fissaggio / Fixing	Appoggio / <i>Freestanding</i>



Rays smart

D883

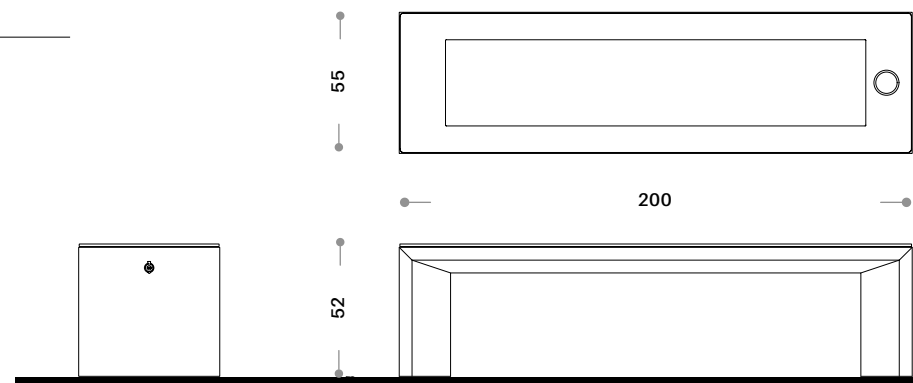

Designer	Dimcar Design Department
Dimensioni / Sizes	200x55 cm H 52 cm - 50 kg
N. posti / No. of seats	4
Materiali / Materials	Acciaio zincato, Vetro stratificato / Galvanized steel, Laminated glass
Fissaggio / Fixing	Predisposizione per tasselli / Predisposition for dowels
Plus / Plus	Prese usb, Ricarica wireless, Illuminazione, Impianto fotovoltaico / Usb socket, Wireless charger, Lighting, Solar power module



Ondina

G470

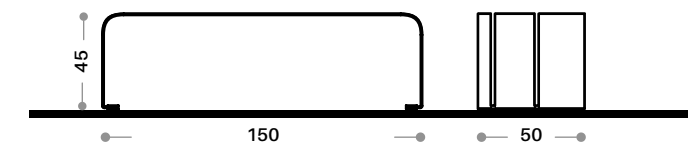

Designer	Gibillero Design
Dimensioni / Sizes	150x50 cm H 45 cm - 55 kg
N. posti / No. of seats	3
Materiali / Materials	Acciaio zincato / Galvanized steel
Fissaggio / Fixing	Predisposizione per tasselli / Predisposition for dowels



Thin curva

D814

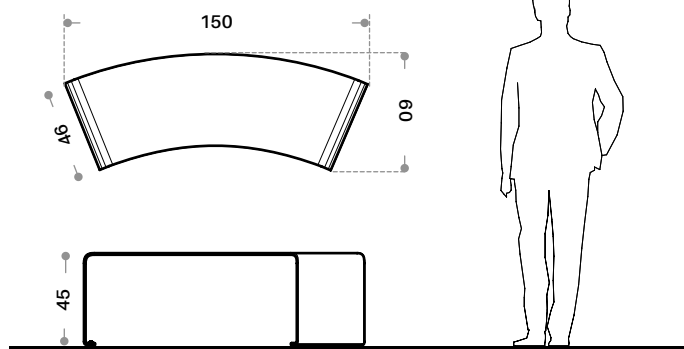

Designer	Dimcar Design Department
Dimensioni / Sizes	150x46x60 cm H 45 cm - 66 kg
N. posti / No. of seats	3
Materiali / Materials	Acciaio zincato / Galvanized steel
Fissaggio / Fixing	Predisposizione per tasselli / Predisposition for dowels

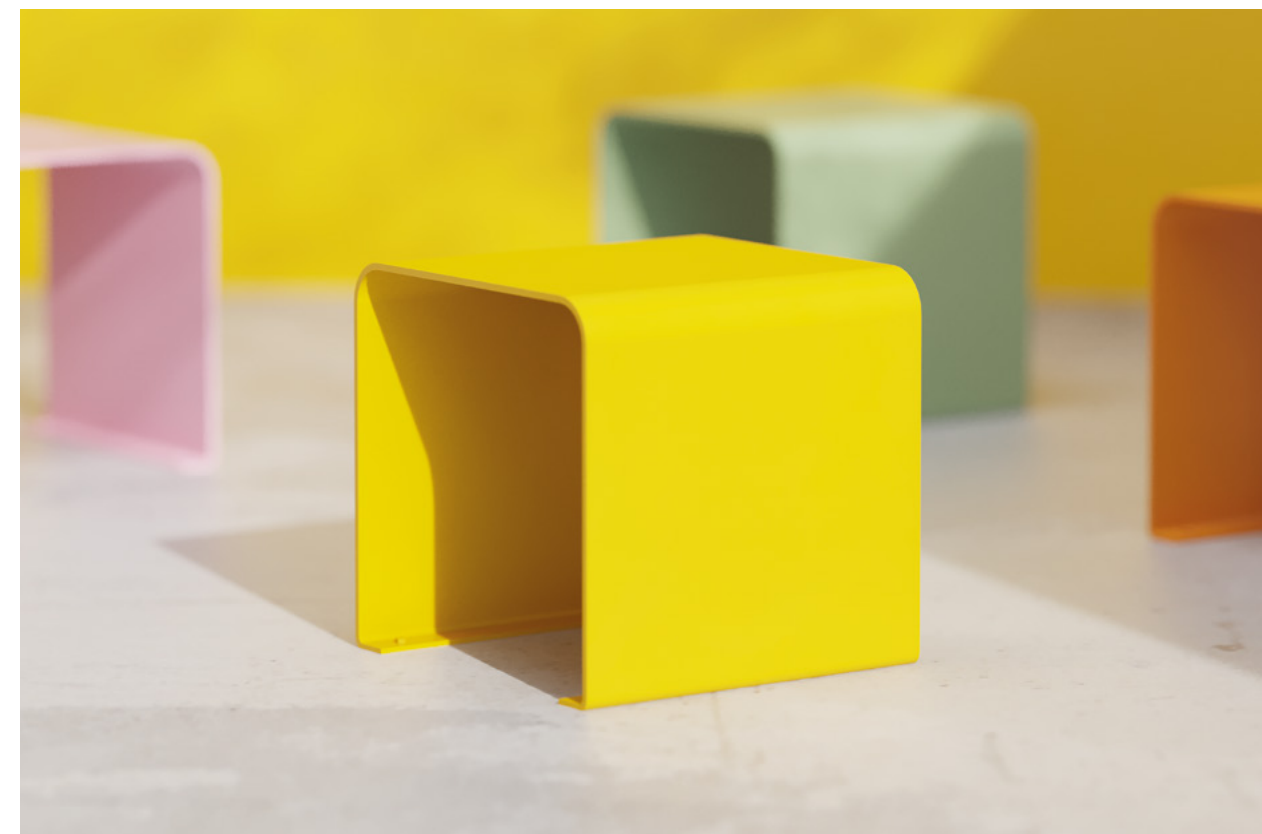

Thin

D813

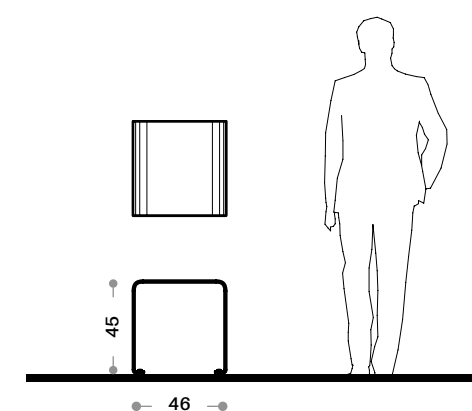

Designer	Dimcar Design Department
Dimensioni / Sizes	46x46 cm H 45 cm - 41 kg
N. posti / No. of seats	1
Materiali / Materials	Acciaio zincato / Galvanized steel
Fissaggio / Fixing	Predisposizione per tasselli / Predisposition for dowels

IL COLORE NON COPRE:
SVELA.
È EMOZIONE, LINGUAGGIO,
DESTINO. LA VOCE DELLA
CITTÀ CHE VERRÀ.

THE COLOR DOES NOT COVER: IT REVEALS.
EMOTION, LANGUAGE, AND DESTINY ARE ALL PART
OF IT. THE VOICE OF THE FUTURE CITY.



MANTIENI PULITI GLI SPAZI
PUBBLICI CON CESTINI
ELEGANTI E FUNZIONALI.



*KEEP PUBLIC SPACES CLEAN WITH ELEGANT
AND FUNCTIONAL BINS.*



CESTINI E CESTONI PORTARIFIUTI DA ESTERNO

OUTDOOR LITTER BINS



INDEX

CESTINI/CESTONI PORTARIFIUTI DA ESTERNO OUTDOOR LITTER BINS

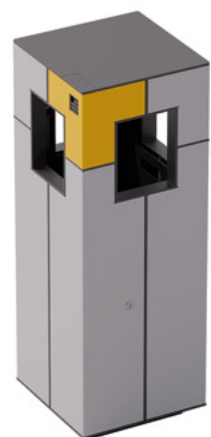

607-CO-M
pag. 198

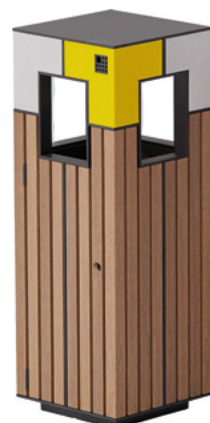

607-CO-L
pag. 199



G490-BIS
pag. 200



G521-BIS
pag. 201



G538
pag. 202



G469-BIS
pag. 203



G502-BIS
pag. 204



G504
pag. 205



G473-BIS
pag. 206



398
pag. 207



452-BIS
pag. 207

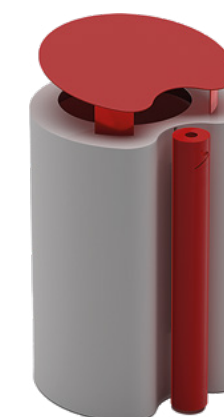

G455-BIS
pag. 208



G515-BIS
pag. 209



438
pag. 210



218-BIS
pag. 211



INDEX

CESTINI/CESTONI PORTARIFIUTI DA ESTERNO OUTDOOR LITTER BINS



399

pag. 212



208-BIS-P

pag. 213



350-BIS

pag. 214



228-BIS

pag. 218



200-BIS

pag. 219



292-BIS

pag. 215



312-BIS

pag. 216



203

pag. 217



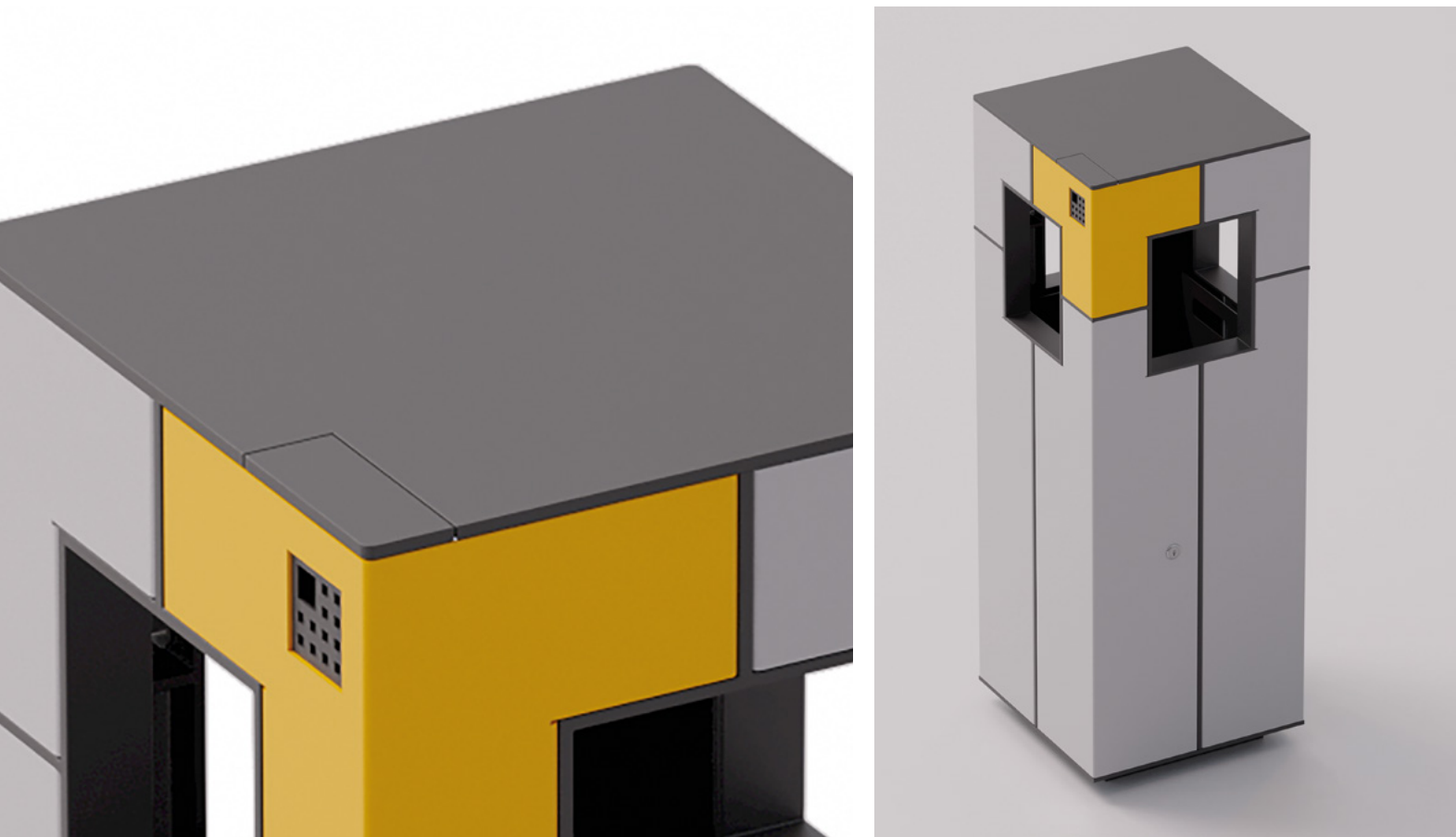

Target

607-CO-M

CESTINO / LITTER BIN

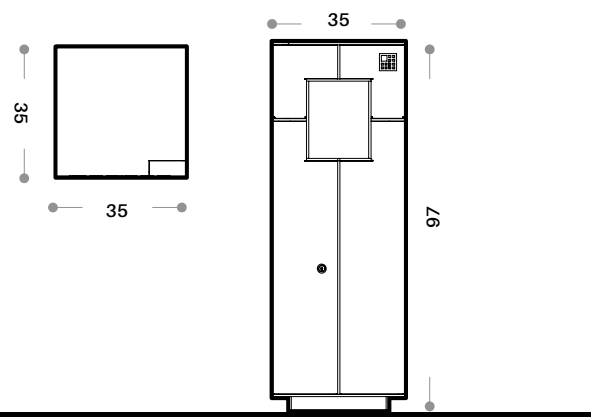

Designer	Dimcar Design Department
Dimensioni / Sizes	35x35 cm H 97 cm - 40 lt - 41 kg
Materiali / Materials	Acciaio zincato / Galvanized steel
Fissaggio / Fixing	Predisposizione per tasselli / Predisposition for dowels
Plus / Plus	Posacenere / Ashtray

Target wood

607-CO-L

CESTINO / LITTER BIN

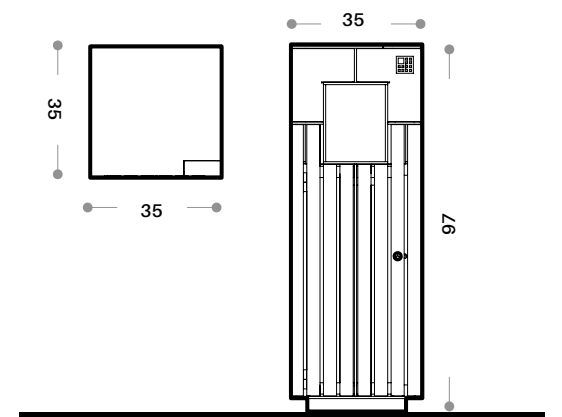

Designer	Dimcar Design Department
Dimensioni / Sizes	35x35 cm H 97 cm - 40 lt - 35 kg
Materiali / Materials	Acciaio zincato, Listoni in legno / Galvanized steel, Wooden planks
Fissaggio / Fixing	Predisposizione per tasselli / Predisposition for dowels
Plus / Plus	Posacenere / Ashtray





Cubik

G490-BIS

CESTONE CON COPERCHIO /
LARGE TRASH BIN WITH LID

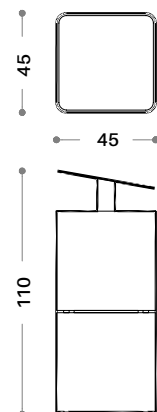

Designer	Gibillero Design
Dimensioni / Sizes	45x45cm H 110 cm - 90 lt - 45 kg
Materiali / Materials	Acciaio zincato / Galvanized steel
Fissaggio / Fixing	Predisposizione per tasselli / Predisposition for dowels



Harry

G521-BIS

CESTONE CON COPERCHIO /
LARGE TRASH BIN WITH LID

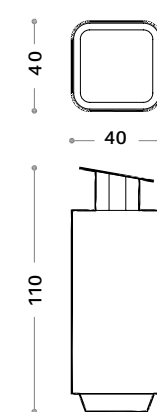

Designer	Gibillero Design
Dimensioni / Sizes	40x40cm H 110 cm - 60 lt - 36 kg
Materiali / Materials	Acciaio zincato / Galvanized steel
Fissaggio / Fixing	Predisposizione per tasselli / Predisposition for dowels





Pop up

G538

CESTONE CON COPERCHIO /
LARGE TRASH BIN WITH LID



G537

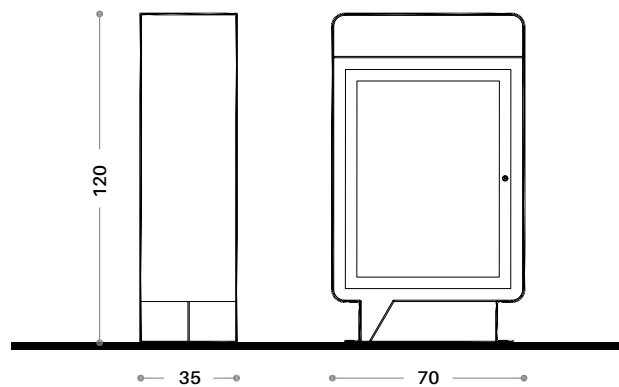

Designer	Gibillero Design
Dimensioni / Sizes	70x35 cm H 120 cm - 38 lt - 75 kg
Materiali / Materials	Acciaio zincato / Galvanized steel
Fissaggio / Fixing	Predisposizione per tasselli / Predisposition for dowels



Miss Thin

G469-BIS

CESTINO CON COPERCHIO /
LITTER BIN WITH LID



G469

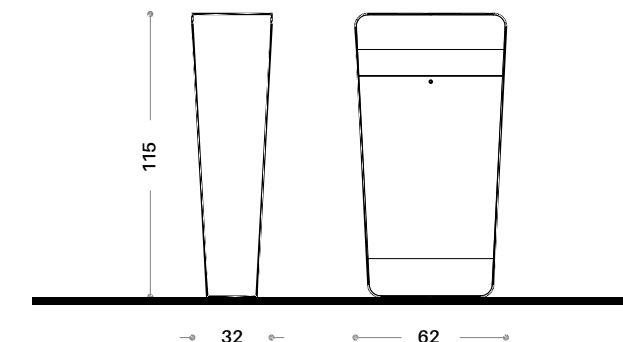

Designer	Gibillero Design
Dimensioni / Sizes	62x32cm H 115 cm - 60 lt - 55 kg
Materiali / Materials	Acciaio zincato / Galvanized steel
Fissaggio / Fixing	Predisposizione per tasselli / Predisposition for dowels





Diapason

G502-BIS

CESTINO ANTI-TERRORISMO CON COPERCHIO / ANTI-TERRORISM DIAPASON LITTER BIN WITH LID

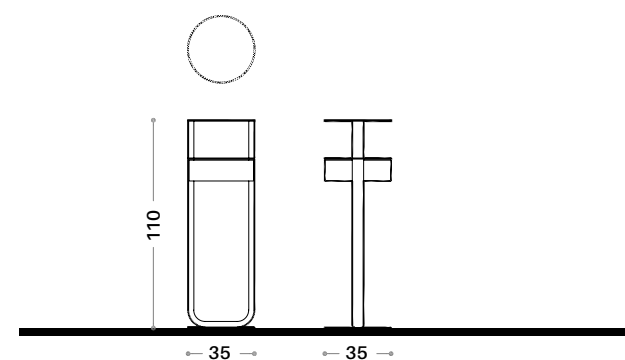

Designer	Gibillero Design
Dimensioni / Sizes	35x35cm H 110 cm - 60 lt - 15 kg
Materiali / Materials	Acciaio zincato / Galvanized steel
Fissaggio / Fixing	Predisposizione per tasselli / Predisposition for dowels

Diapason

G504

CESTINO CON COPERCHIO / LITTER BIN WITH LID

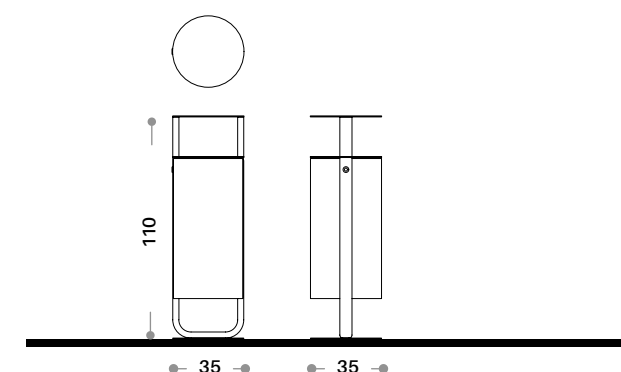

Designer	Gibillero Design
Dimensioni / Sizes	35x35cm H 110 cm - 30 lt - 34 kg
Materiali / Materials	Acciaio zincato / Galvanized steel
Fissaggio / Fixing	Predisposizione per tasselli / Predisposition for dowels



Ziggy

G473-BIS

CESTONE CON COPERCHIO
E POSACENERE / LARGE TRASH
BIN WITH LID AND ASHTRAY



G473

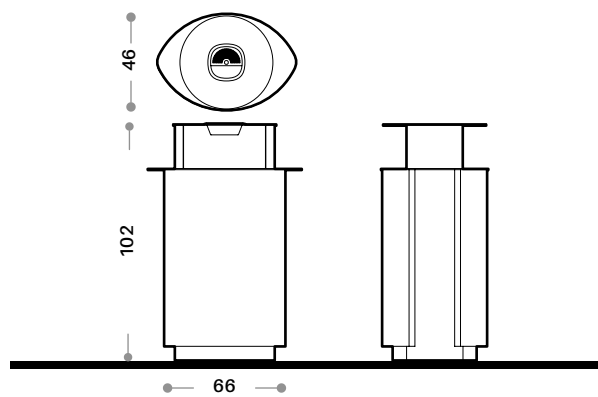

Designer	Gibillero
Dimensioni / Sizes	66x46 cm H 102 cm - 70 lt - 46 kg
Materiali / Materials	Acciaio zincato / Galvanized steel
Fissaggio / Fixing	Predisposizione per tasselli / Predisposition for dowels



Tower

398

CESTONE / LARGE TRASH BIN

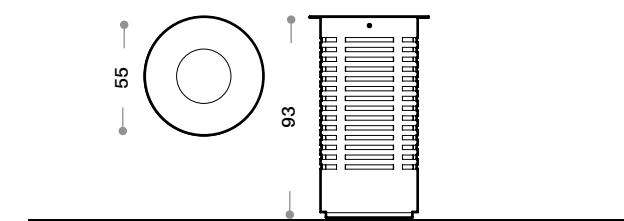

Designer	Dimcar Design Department
Dimensioni / Sizes	55x55 cm H 93 cm - 100 lt - 36 kg
Materiali / Materials	Acciaio zincato / Galvanized steel
Fissaggio / Fixing	Predisposizione per tasselli / Predisposition for dowels



Phuro One

452-BIS

CESTONE / LARGE TRASH BIN

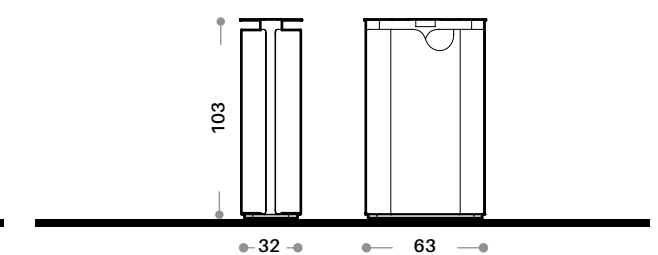

Designer	Dimcar Design Department
Dimensioni / Sizes	63x32 cm H 103 cm - 100 lt - 41 kg
Materiali / Materials	Acciaio zincato / Galvanized steel
Fissaggio / Fixing	Predisposizione per tasselli / Predisposition for dowels
Plus / Plus	Posaceneri / Ashtray



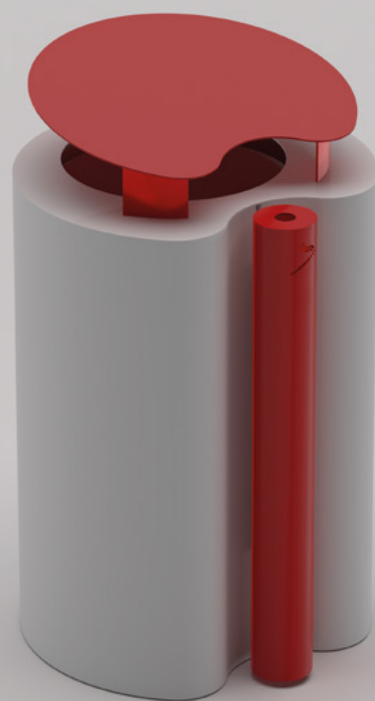

Alvarian

G455-BIS

CESTONE CON COPERCHIO /
LARGE TRASH BIN WITH LID

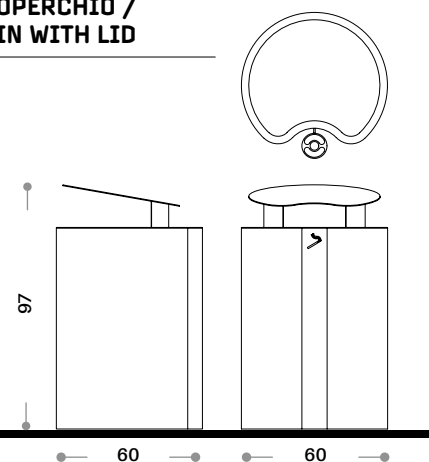

Designer	Gibillero Design
Dimensioni / Sizes	60x60 cm H 97 cm - 90 lt - 53 kg
Materiali / Materials	Acciaio zincato / Galvanized steel
Fissaggio / Fixing	Predisposizione per tasselli / Predisposition for dowels
Plus / Plus	Posacenere / Ashtray

Bob

G515-BIS

CESTONE CON COPERCHIO E
POSACENERE /
LARGE TRASH BIN WITH LID AND
ASHTRAY

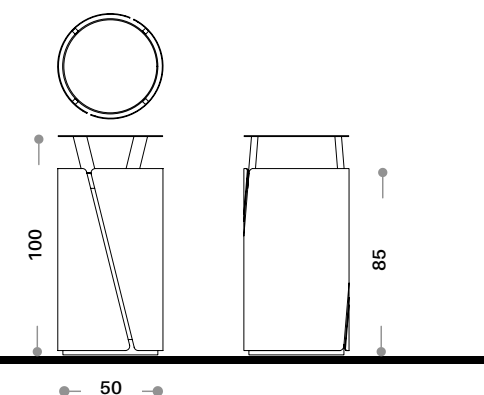

Designer	Gibillero Design
Dimensioni / Sizes	50x50cm H 100 cm - 120 lt - 51 kg
Materiali / Materials	Acciaio zincato / Galvanized steel
Fissaggio / Fixing	Predisposizione per tasselli / Predisposition for dowels





Klar

438

CESTONE / LARGE TRASH BIN

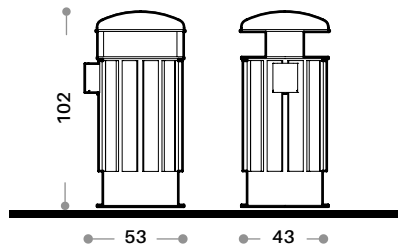

Designer	Dimcar Design Department
Dimensioni / Sizes	43x53 cm H 102 cm - 85 lt - 27 kg
Materiali / Materials	Acciaio zincato, Listoni in legno / Galvanized steel, Wooden planks
Fissaggio / Fixing	Predisposizione per tasselli / Predisposition for dowels
Plus / Plus	Posacenere / Ashtray



Elmo

218-BIS

CESTONE CON POSACENERE /
LARGE TRASH BIN WITH ASHTRAY

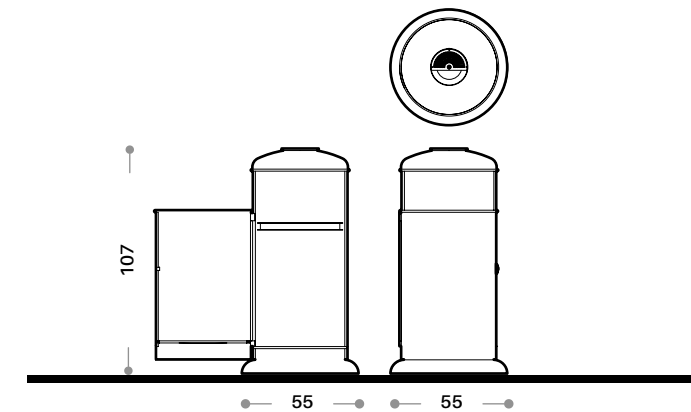

Designer	Dimcar Design Department
Dimensioni / Sizes	55x55cm H 107 cm - 60 lt - 65 kg
Materiali / Materials	Acciaio zincato, Cemento bianco liscio, Acciaio Inox / Galvanized steel, White smooth concrete, Stainless Steel
Fissaggio / Fixing	Appoggio / Freestanding





Ellipso

399

CESTINO / LITTER BIN

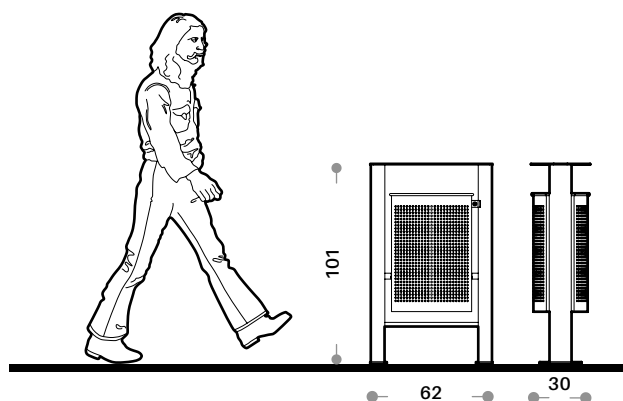

Designer	Dimcar Design Department
Dimensioni / Sizes	62x30 cm H 101 cm - 55 lt - 15 kg
Materiali / Materials	Acciaio zincato / Galvanized steel
Fissaggio / Fixing	Predisposizione per tasselli / Predisposition for dowels

Taormina

208-BIS-P

CESTINO CON COPERCHIO
E POSACENERE /
LITTER BIN WITH LID AND ASHTRAY

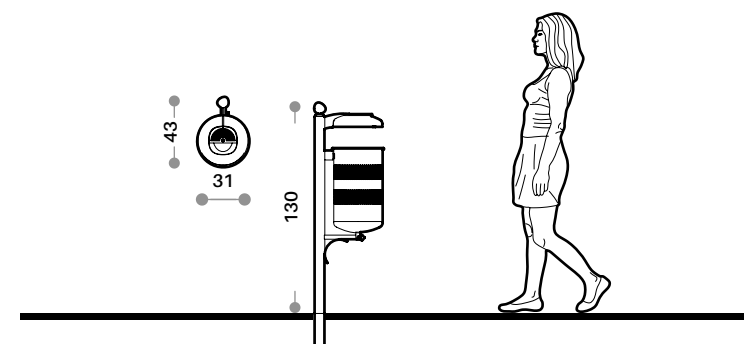

Designer	Dimcar Design Department
Dimensioni / Sizes	31x43 cm H 130 cm - 35 lt - 12 kg
Materiali / Materials	Acciaio zincato, Acciaio Inox / Galvanized steel, Stainless Steel
Fissaggio / Fixing	Cementazione / Cementation





Mida

312-BIS

**CESTINO CON COPERCHIO /
LITTER BIN WITH LID**

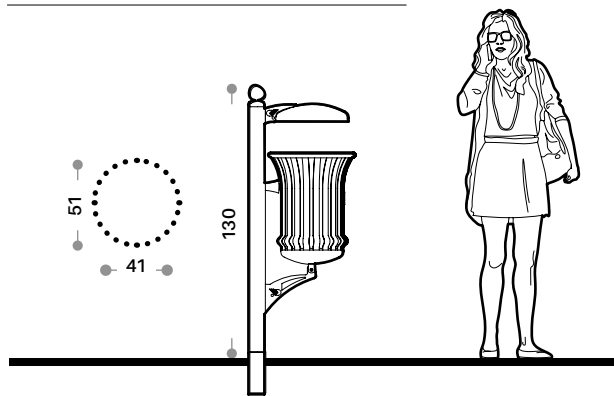

Designer	Dimcar Design Department
Dimensioni / Sizes	41x51 cm H 130 cm - 35 lt - 15 kg
Materiali / Materials	Acciaio zincato / Galvanized steel
Fissaggio / Fixing	Cementazione / Cementation



Pirro

203

**CESTINO CON COPERCHIO /
LITTER BIN WITH LID**

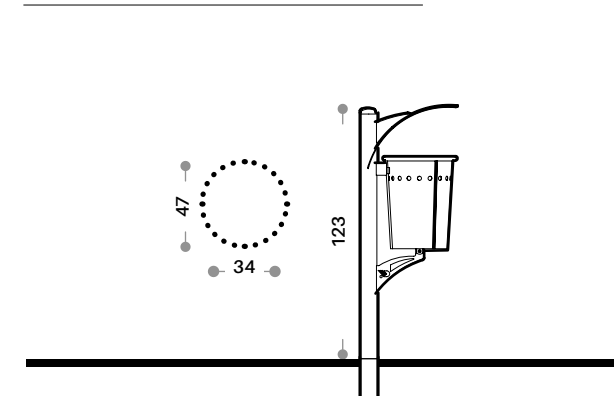

Designer	Dimcar Design Department
Dimensioni / Sizes	47x34 cm H 123 cm - 30 lt - 15 kg
Materiali / Materials	Acciaio zincato / Galvanized steel
Fissaggio / Fixing	Cementazione / Cementation





Mida

228-BIS

**CESTONE CON COPERCHIO
E POSACENERE /
LARGE TRASH BIN WITH LID
AND ASHTRAY**

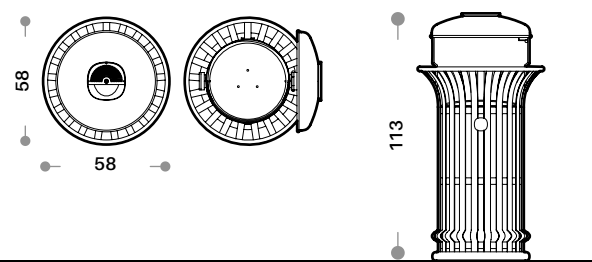

Designer	Dimcar Design Department
Dimensioni / Sizes	58x58 cm H 113 cm - 70 lt - 34 kg
Materiali / Materials	Acciaio zincato, acciaio inox / Galvanized steel, stainless steel
Fissaggio / Fixing	Predisposizione per tasselli / Predisposition for dowels



Virgo

200-BIS

**CESTONE CON COPERCHIO
APRIBILE /
LARGE TRASH BIN WITH
OPENABLE LID**

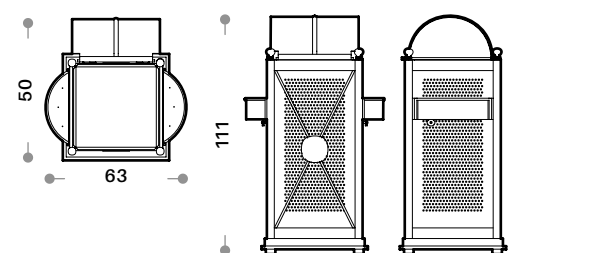

Designer	Dimcar Design Department
Dimensioni / Sizes	63x50 cm H 111 cm - 85 lt - 34 kg
Materiali / Materials	Acciaio zincato / Galvanized steel
Fissaggio / Fixing	Predisposizione per tasselli / Predisposition for dowels
Plus / Plus	Posaceneri / Ashtray



PROMUOVI LA SOSTENIBILITÀ
CON SOLUZIONI PER UNA
RACCOLTA DIFFERENZIATA
EFFICIENTE.

*PROMOTE SUSTAINABILITY WITH SOLUTIONS
FOR EFFICIENT WASTE SORTING.*

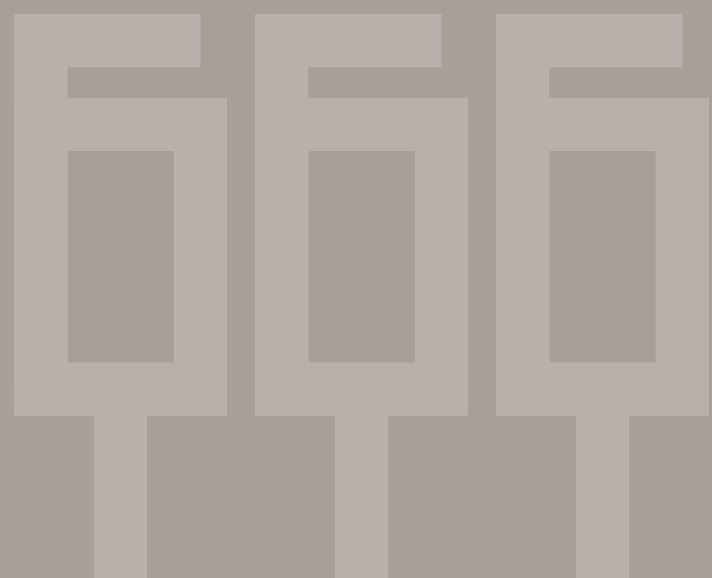

**CESTINI E CESTONI
RACCOLTA
DIFFERENZIATA**
*OUTDOOR RECYCLING
LITTER BINS*



INDEX

CESTINI E CESTONI PORTARIFIUTI DA ESTERNO OUTDOOR RECYCLING LITTER BINS



G456

pag. 225

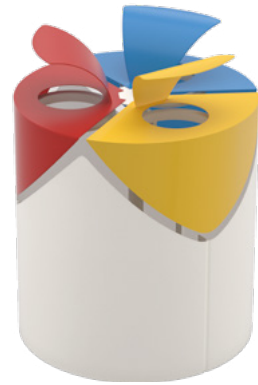

G492-BIS

pag. 226



G493-BIS

pag. 227



G525

pag. 228



312-BIS-T

pag. 229



G508

pag. 230

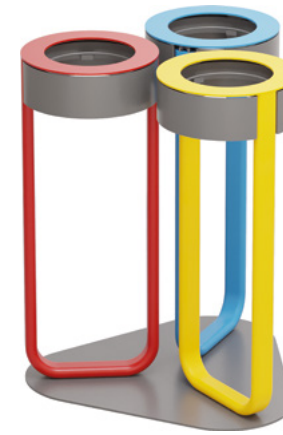

G507

pag. 230



203-T

pag. 231



423

pag. 231



377-BIS-CLS

pag. 232



440

pag. 233



434

pag. 234



360-BIS

pag. 235



G460

pag. 237



Benjamin

G456

CESTONE /
RECYCLING LARGE TRASH BIN

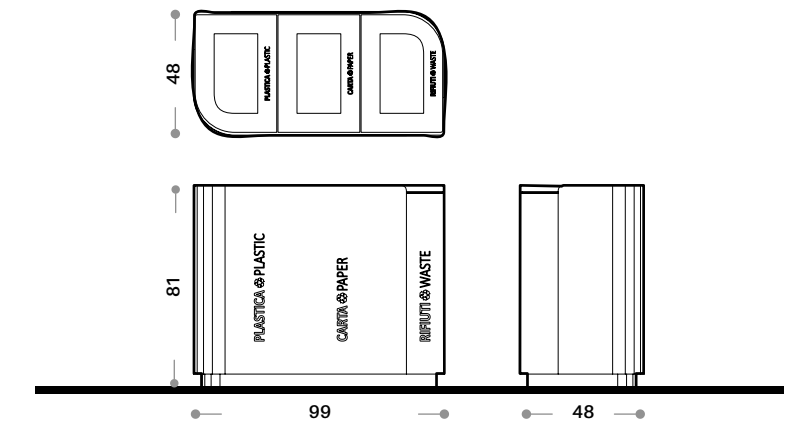

Designer	Gibillero Design
Dimensioni / Sizes	99x48 cm H 81 cm - 135 lt - 76 kg
Materiali / Materials	Acciaio zincato / Galvanized steel
Fissaggio / Fixing	Predisposizione per tasselli / Predisposition for dowels

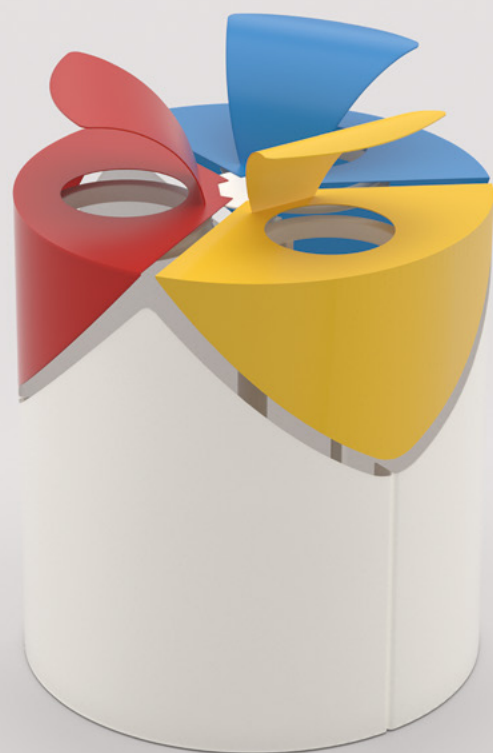

Kurt Three

G492-BIS

CESTONE CON COPERCHIO /
KURT THREE LARGE TRASH BIN
WITH LID



G492

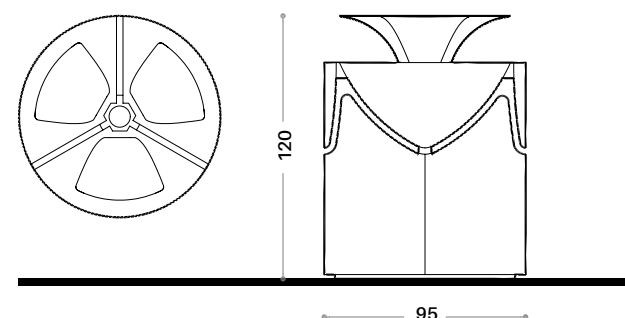

Designer	Gibillero Design
Dimensioni / Sizes	95x95 cm H 120 cm - 225 lt - 87 kg
Materiali / Materials	Acciaio zincato / Galvanized steel
Fissaggio / Fixing	Predisposizione per tasselli / Predisposition for dowels

Kurt four

G493-BIS

CESTONE CON COPERCHIO /
KURT FOUR LARGE TRASH BIN WITH LID



G493

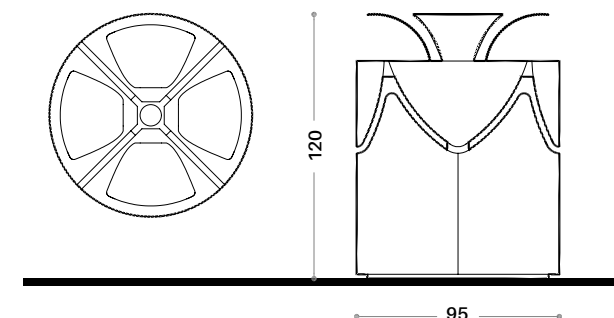

Designer	Gibillero Design
Dimensioni / Sizes	95x95 cm H 120 cm - 300 lt - 106 kg
Materiali / Materials	Acciaio zincato / Galvanized steel
Fissaggio / Fixing	Predisposizione per tasselli / Predisposition for dowels



Sam

G525

**CESTONE /
LARGE RECYCLING TRASH BIN**

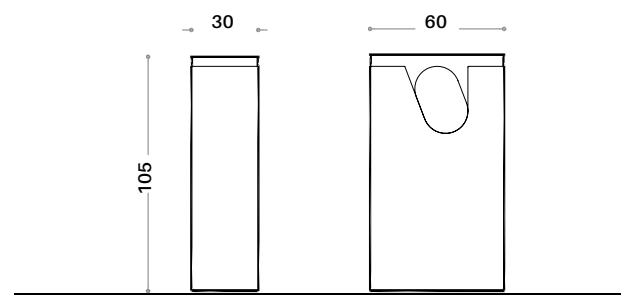

Designer	Gibillero Design
Dimensioni / Sizes	60x30 cm H 105 cm - 80 lt - 43 kg
Materiali / Materials	Acciaio zincato / Galvanized steel
Fissaggio / Fixing	Predisposizione per tasselli / Predisposition for dowels



Mida triplo

312-BIS-T

**CESTINO TRIPLO CON COPERCHIO
E POSACENERE /
TRIPLE MIDA RECYCLING LITTER
BIN WITH LID AND ASHTRAY**

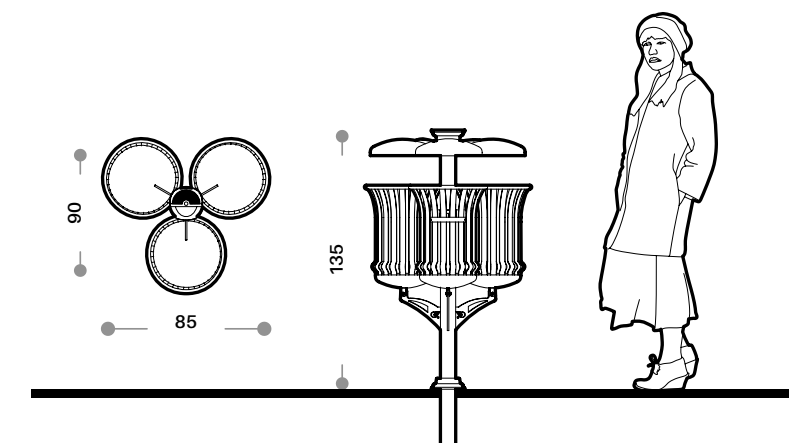

Designer	Dimcar Design Department
Dimensioni / Sizes	90x85 cm H 135 cm - 105 lt - 50 kg
Materiali / Materials	Acciaio zincato, Acciaio Inox / Galvanized steel, Stainless Steel
Fissaggio / Fixing	Cementazione / Cementation



Diapason Tris

G508

CESTINO TRIPLO /
DIAPASON TRIS RECYCLING LITTER BIN

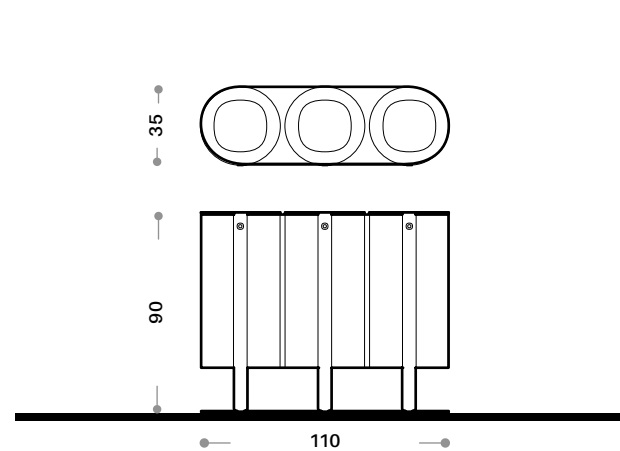

Designer	Gibillero Design
Dimensioni / Sizes	110x35 cm H 90 cm - 90 lt - 92 kg
Materiali / Materials	Acciaio zincato / Galvanized steel
Fissaggio / Fixing	Predisposizione per tasselli / Predisposition for dowels



Diapason Tris

G507

CESTINO TRIPLO ANTITERRORISMO /
ANTI-TERRORISM DIAPASON TRIS
RECYCLING LITTER BIN

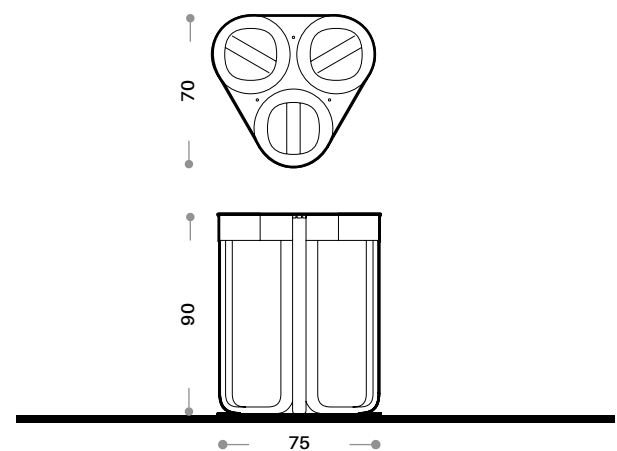

Designer	Gibillero Design
Dimensioni / Sizes	75x70cm H 90 cm - 180 lt - 43 kg
Materiali / Materials	Acciaio zincato / Galvanized steel
Fissaggio / Fixing	Predisposizione per tasselli / Predisposition for dowels



Pirro Triplo

203-T

CESTINO /
PIRRO TRIPLE RECYCLING LITTER BIN

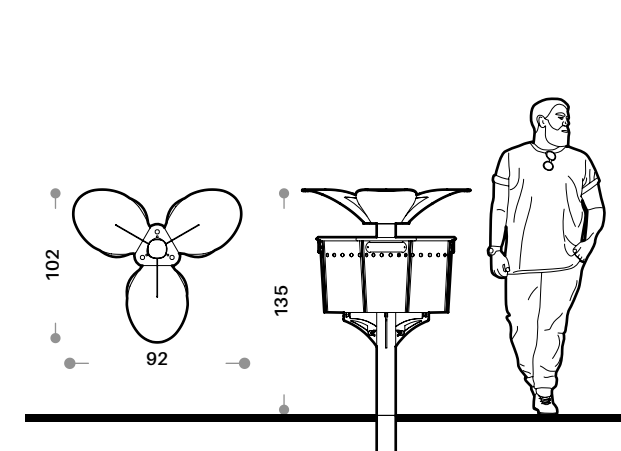

Designer	Dimcar Design Department
Dimensioni / Sizes	92x102 cm H 135 cm - 90 lt - 48 kg
Materiali / Materials	Acciaio zincato / Galvanized steel
Fissaggio / Fixing	Cementazione / Cementation



Ekos

423

CESTINO TRIPLO /
EKOS RECYCLING LITTER BIN

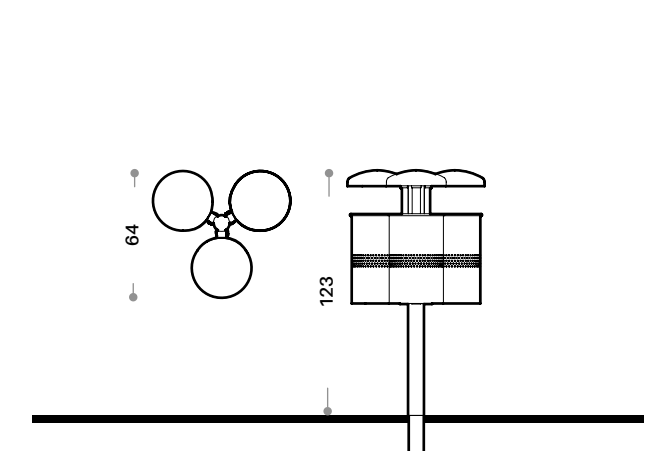

Designer	Dimcar Design Department
Dimensioni / Sizes	70x64 cm H 123 cm - 75 lt - 29 kg
Materiali / Materials	Acciaio zincato / Galvanized steel
Fissaggio / Fixing	Cementazione / Cementation





Elios

377-BIS-CLS

**CESTONE CON COPERCHIO
E BASAMENTO IN CLS /
RECYCLING LITTER BIN WITH LID AND
CLS BASEMENT**

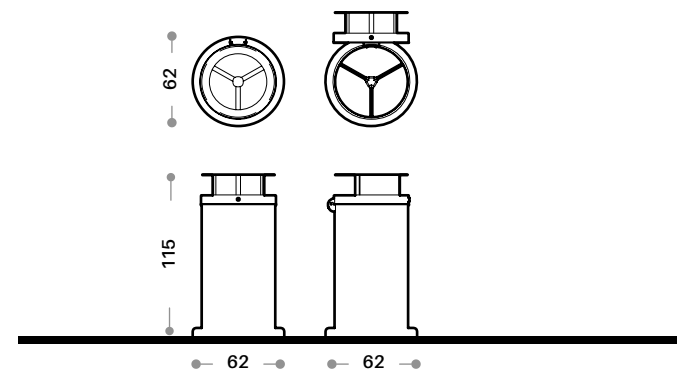

Designer	Dimcar Design Department
Dimensioni / Sizes	62x62cm H 115 cm - 170 lt - 80 kg
Materiali / Materials	Acciaio zincato / Galvanized steel
Fissaggio / Fixing	Appoggio / Freestanding

Geo

440

**CESTONE /
RECYCLING LARGE TRASH BIN**

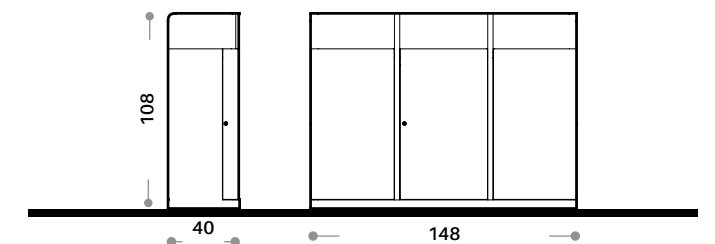

Designer	Dimcar Design Department
Dimensioni / Sizes	148x40cm H 108 cm - 270 lt - 135 kg
Materiali / Materials	Acciaio zincato / Galvanized steel
Fissaggio / Fixing	Predisposizione per tasselli / Predisposition for dowels



Hex

434

**CESTONE /
RECYCLING LARGE TRASH BIN**

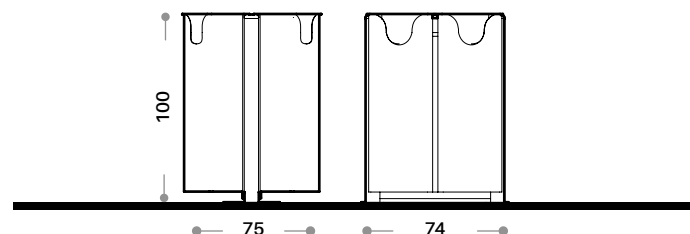

Designer	Dimcar Design Department
Dimensioni / Sizes	74x75 cm H 100 cm - 240 lt - 83 kg
Materiali / Materials	Acciaio zincato / Galvanized steel
Fissaggio / Fixing	Predisposizione per tasselli / Predisposition for dowels

Paint

360-BIS

**CESTONE /
RECYCLING LARGE TRASH BIN**

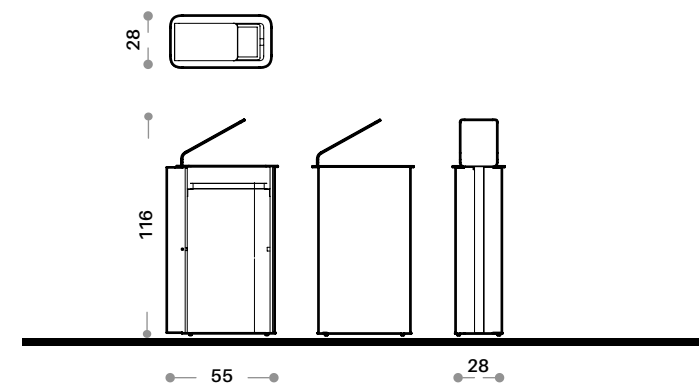

Designer	Dimcar Design Department
Dimensioni / Sizes	55x28cm H 116 cm - 80 lt - 35 kg
Materiali / Materials	Acciaio zincato / Galvanized steel
Fissaggio / Fixing	Predisposizione per tasselli / Predisposition for dowels





Tobia

G460

CESTINO / DOG WASTE LITTER BIN

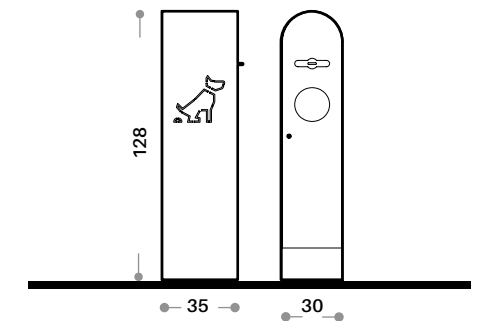

Designer	Gibillero Design
Dimensioni / Sizes	30x35 cm H 128 cm - 23 lt - 42 kg
Materiali / Materials	Acciaio zincato / Galvanized steel
Fissaggio / Fixing	Predisposizione per tasselli / Predisposition for dowels
Plus / Plus	Dispenser sacchetti integrato / Integrated dog-bags dispenser
Optional / Optional	Sacchetti clean dog-kit / Clean dog-kit bags

RIDUCI L'INQUINAMENTO
URBANO CON POSACENERE
DISCRETI E DI DESIGN.

*REDUCE URBAN POLLUTION WITH DISCREET
AND STYLISH ASHTRAYS.*



POSACENERE *OUTDOOR ASHTRAYS*



INDEX

POSACENERE ASHTRAYS



G530

pag. 242



G480

pag. 243



410

pag. 244



248

pag. 244



408M

pag. 245



367

pag. 245



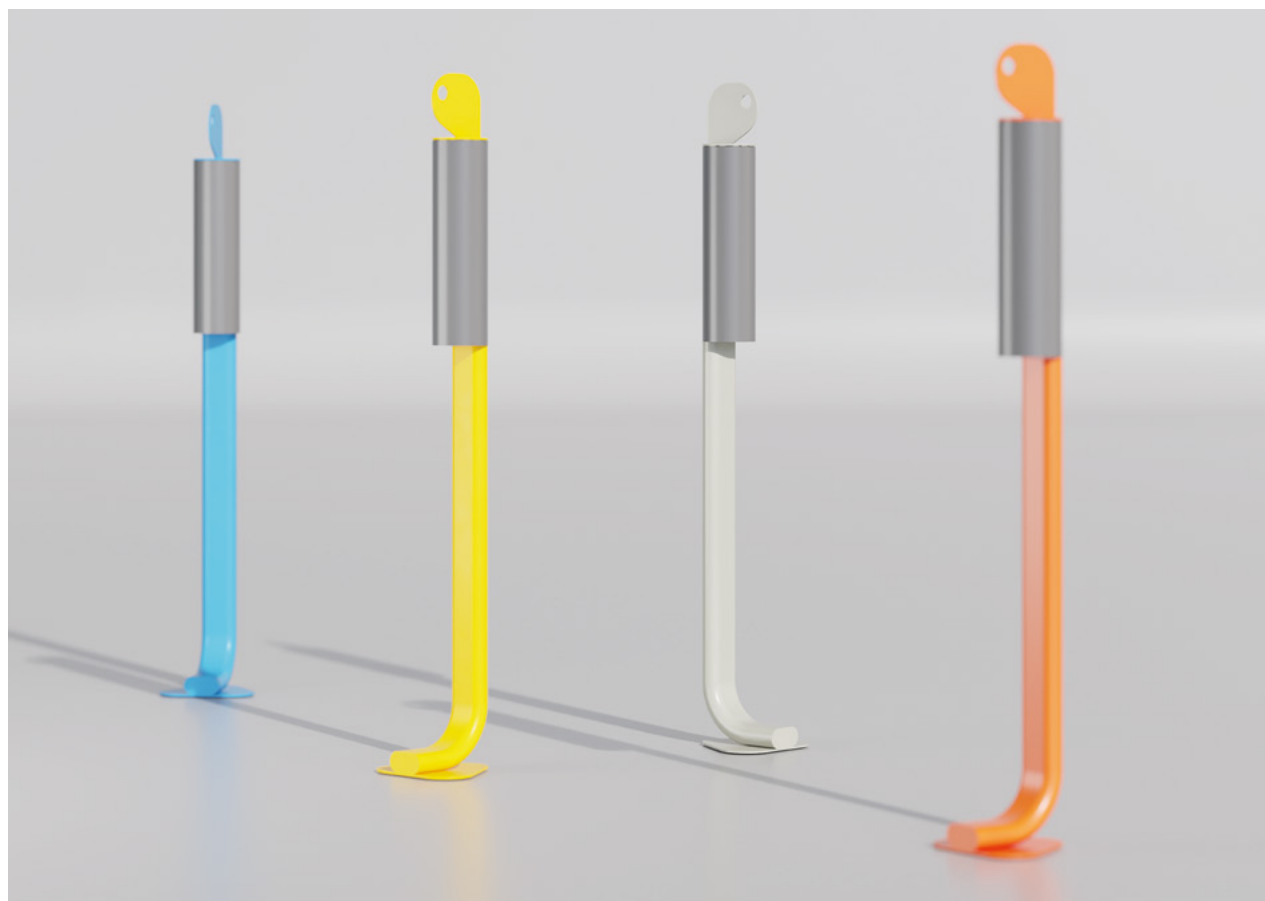

ZigoZago

G530

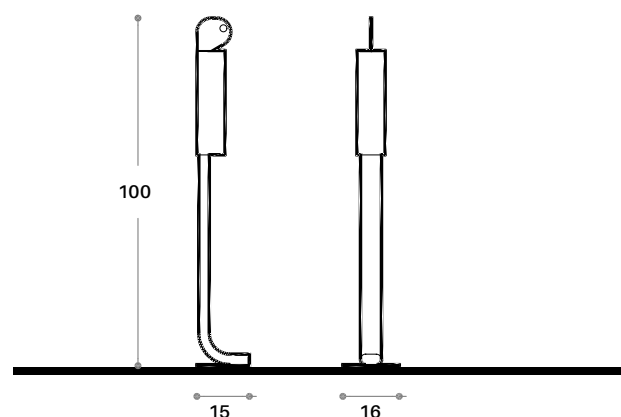

Designer	Gibillero Design
Dimensioni / Sizes	16x15 cm H 100 cm - 5 kg
Materiali / Material	Acciaio zincato / Galvanized steel
Fissaggio / Fixing	Predisposizione per tasselli / Predisposition for dowels



Charlie

G480

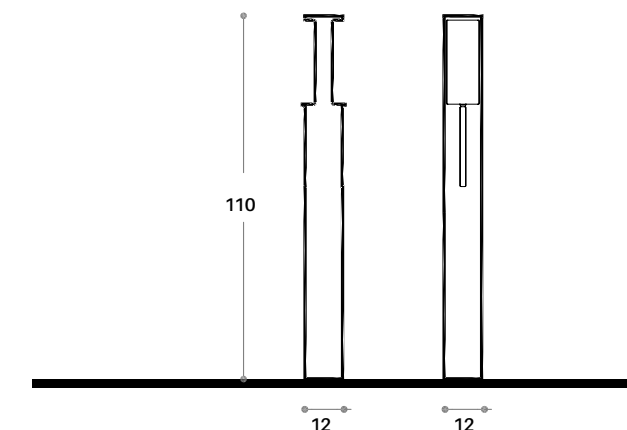

Designer	Gibillero Design
Dimensioni / Sizes	12x12cm H 110 cm - 11 kg
Materiali / Material	Acciaio zincato / Galvanized steel
Fissaggio / Fixing	Predisposizione per tasselli / Predisposition for dowels





Liberty

410



Olimpic

248



Cenerino

408M

CON ATTACCO A MURO /
ASHTRAY WALL MOUNTING



Fumino

367

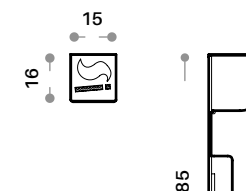
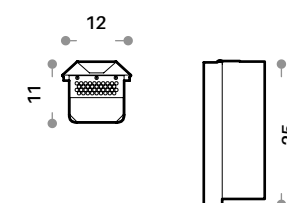
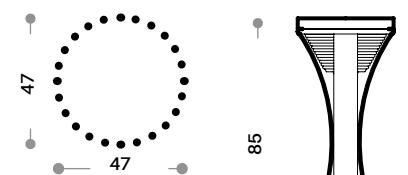
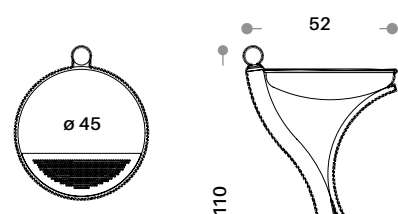

Designer	Dimcar Design Department
Dimensioni / Sizes	45x52 cm H 110 cm - 13 kg
Materiali / Materials	Acciaio zincato / Galvanized steel
Fissaggio / Fixing	Predisposizione per tasselli / Predisposition for dowels

Designer	Dimcar Design Department
Dimensioni / Sizes	47x47 cm H 85 cm - 17 kg
Materiali / Materials	Acciaio zincato / Galvanized steel
Fissaggio / Fixing	Predisposizione per tasselli / Predisposition for dowels

Designer	Dimcar Design Department
Dimensioni / Sizes	12x11cm H 25 cm - 2 kg
Materiali / Materials	Acciaio zincato, Acciaio Inox / Galvanized steel, Stainless Steel
Fissaggio / Fixing	Predisposizione per tasselli / Predisposition for dowels

Designer	Dimcar Design Department
Dimensioni / Sizes	15x16cm H 85 cm - 13kg
Materiali / Materials	Acciaio zincato / Galvanized steel
Fissaggio / Fixing	Predisposizione per tasselli / Predisposition for dowels





L'ESPERIENZA DEI PADRI
NON SI PERDE, VIVE NELLE
NOSTRE MANI.
OGNI GESTO CHE COMPIAMO,
CAMMINA NEL SOLCO DI CHI
È VENUTO PRIMA DI NOI.

*FATHERS' EXPERIENCES ARE STILL
PRESENT IN OUR HANDS.
WE ARE FOLLOWING THE FOOTSTEPS
OF THOSE WHO HAVE COME BEFORE US
IN EVERY GESTURE WE MAKE.*

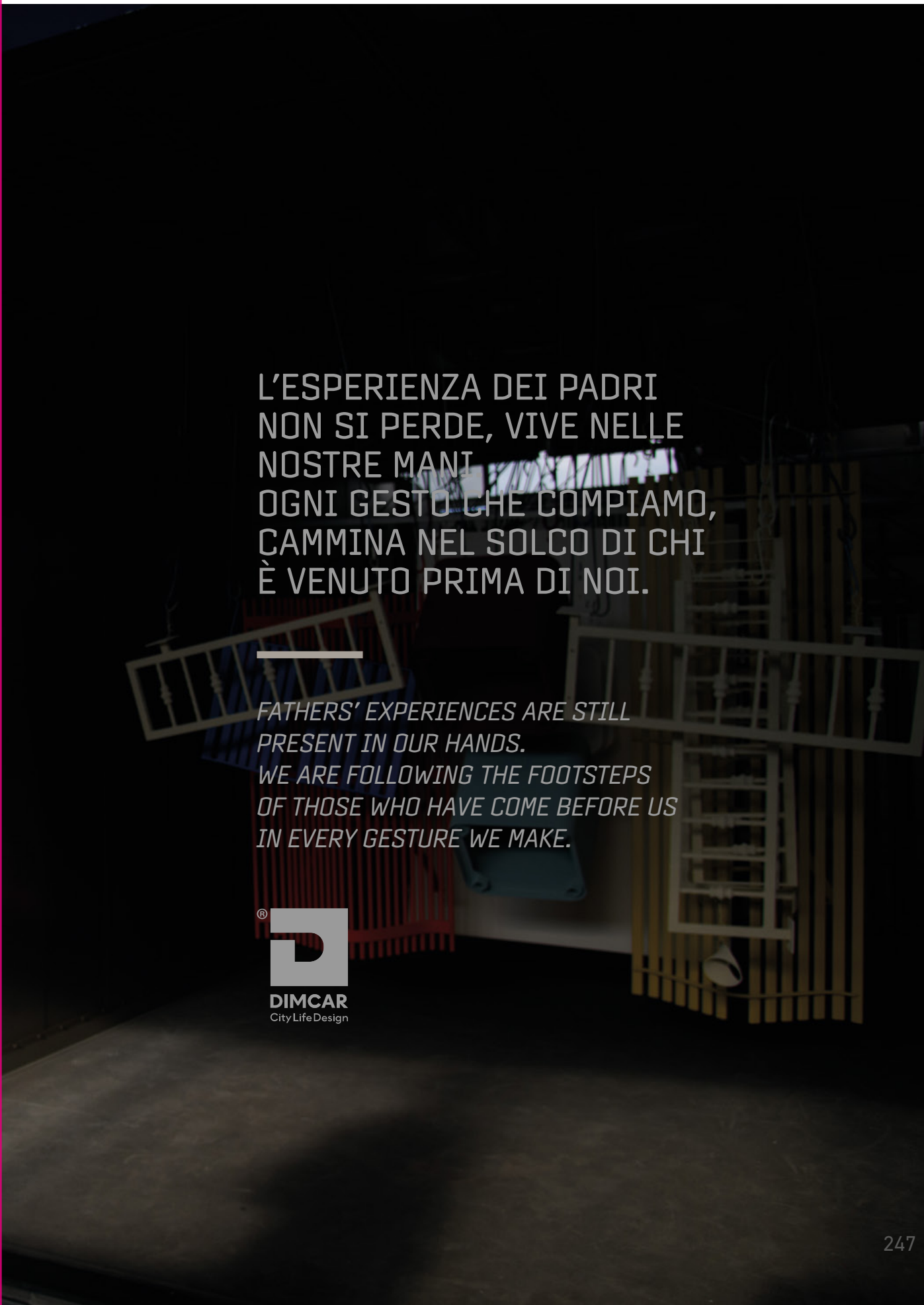
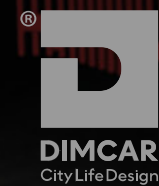



CREA SPAZI CONVIVIALI PER
IL TEMPO LIBERO ALL'APERTO.



*CREATE CONVIVIAL SPACES
FOR OUTDOOR LEISURE TIME.*

TAVOLI DA PICNIC *PICNIC TABLES*



Tavoli da picnic
Picnic Tables





INDEX

TAVOLI DA PICNIC PICNIC TABLES



G498

pag. 253



G497

pag. 253



484-OK

pag. 258



D831

pag. 259

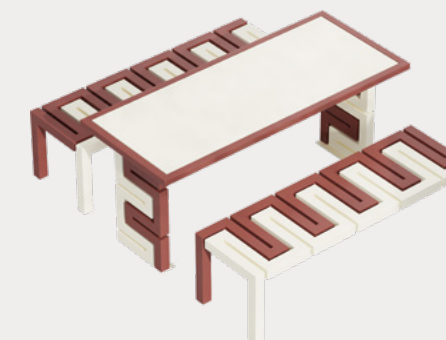

482

pag. 254



483-OK

pag. 255





Holyday



G498

Designer	Gibillero Design
Dimensioni / Sizes	190x190 cm H 82 cm - 100 kg
N. posti / No. of seats	6
Materiali / Materials	Acciaio zincato, Listoni in legno / Galvanized steel, Wooden planks
Fissaggio / Fixing	Predisposizione per tasselli / Preposition for dowels

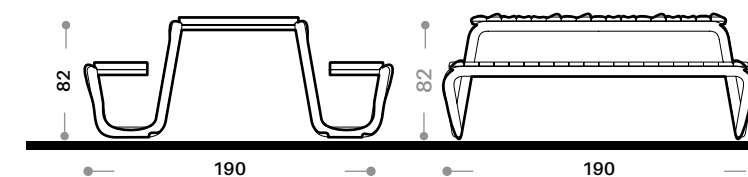

Weekend



G497

Designer	Gibillero Design
Dimensioni / Sizes	181x176 cm H 77 cm - 104 kg
N. posti / No. of seats	6
Materiali / Materials	Acciaio zincato, Listoni in legno / Galvanized steel, Wooden planks
Fissaggio / Fixing	Predisposizione per tasselli / Preposition for dowels





Break

482



Designer	Dimcar Design Department
Dimensioni / Sizes	190x185 cm H 80 cm - 89 kg
N. posti / No. of seats	6
Materiali / Materials	Acciaio zincato, Listoni in legno / Galvanized steel, Wooden planks
Fissaggio / Fixing	Predisposizione per tasselli / Predisposition for dowels



Essenza

483-OK

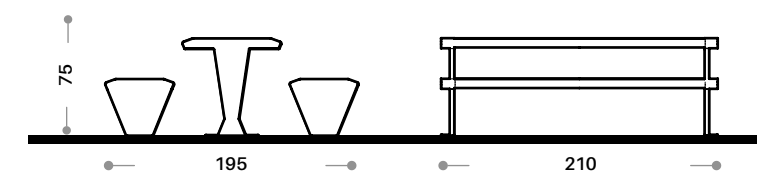

Designer	Dimcar Design Department
Dimensioni / Sizes	210x195 cm H 75 cm - 170 kg
N. posti / No. of seats	6
Materiali / Materials	Acciaio zincato, Listoni in legno / Galvanized steel, Wooden planks
Fissaggio / Fixing	Predisposizione per tasselli / Predisposition for dowels







Round

484-OK

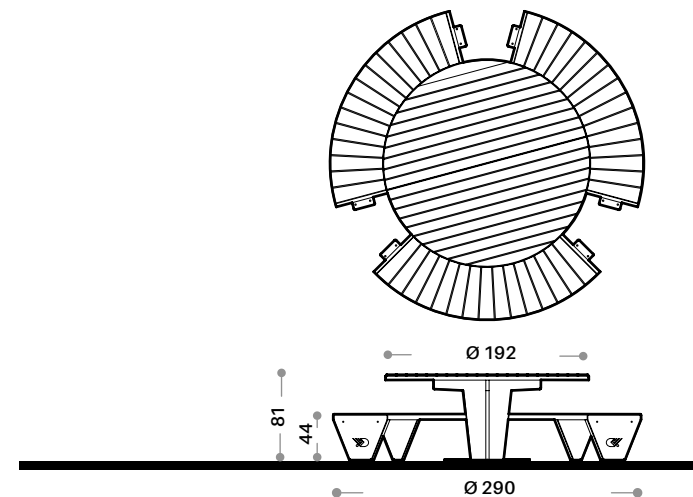

Designer	Dimcar Design Department
Dimensioni / Sizes	290x290 cm H 81 cm - 286 kg
N. posti / No. of seats	12
Materiali / Materials	Acciaio zincato, Listoni in legno / Galvanized steel, Wooden planks
Fissaggio / Fixing	Predisposizione per tasselli / Predisposition for dowels

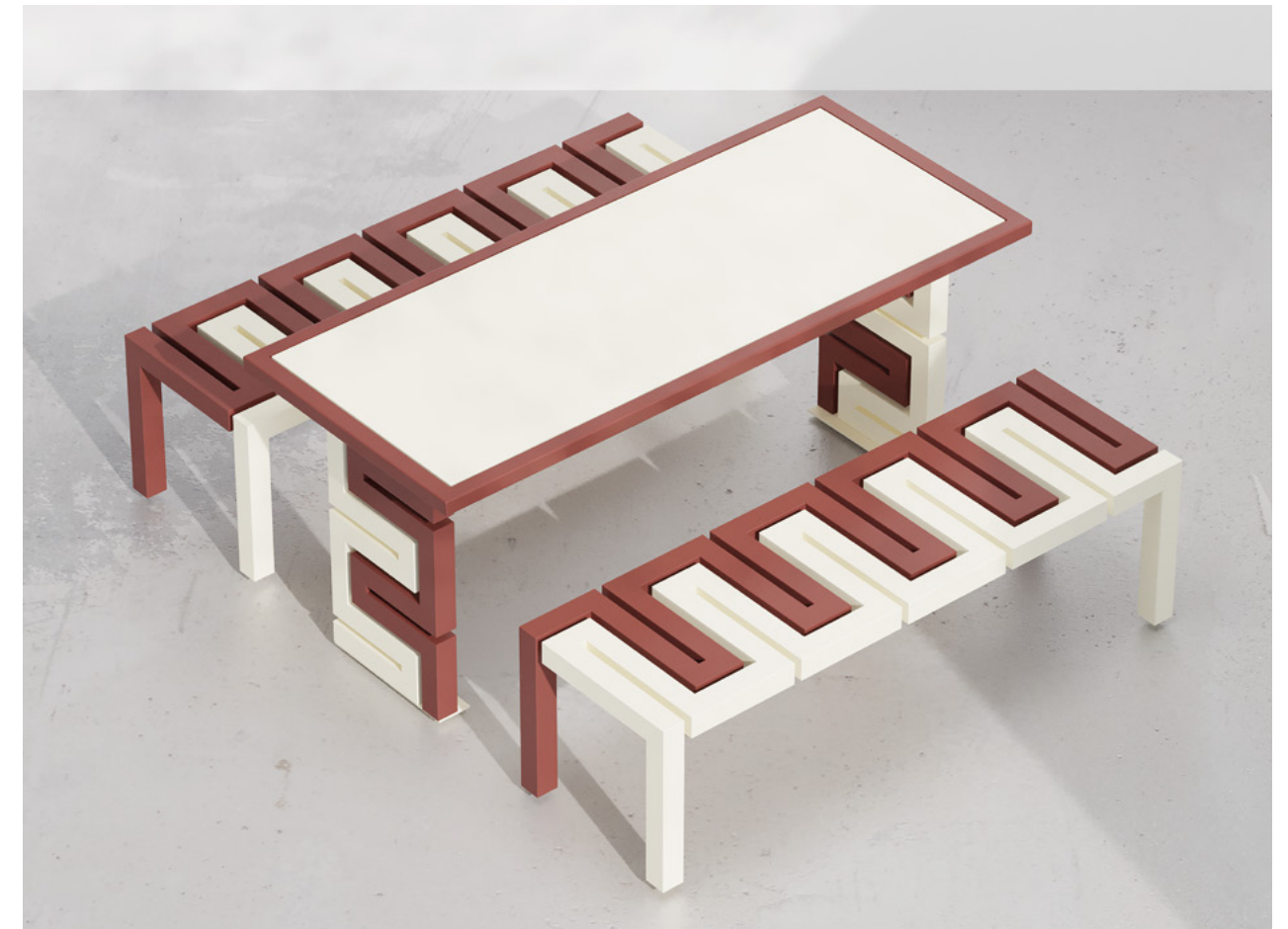

Snake

D831

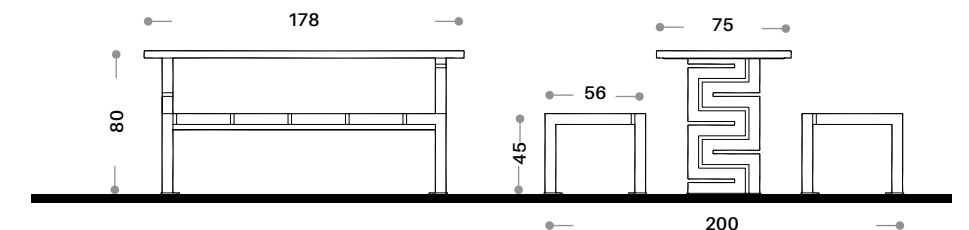

Designer	Dimcar Design Department
Dimensioni / Sizes	178x200 cm H 80 cm - 201 kg
N. posti / No. of seats	6
Materiali / Materials	Acciaio zincato / Galvanized steel
Fissaggio / Fixing	Predisposizione per tasselli / Predisposition for dowels

AGGIUNGI UN TOCCO DI
VERDE PER MIGLIORARE
L'ESTETICA E IL BENESSERE
URBANO.

*ADD A TOUCH OF GREENERY TO ENHANCE
AESTHETICS AND URBAN WELL-BEING.*

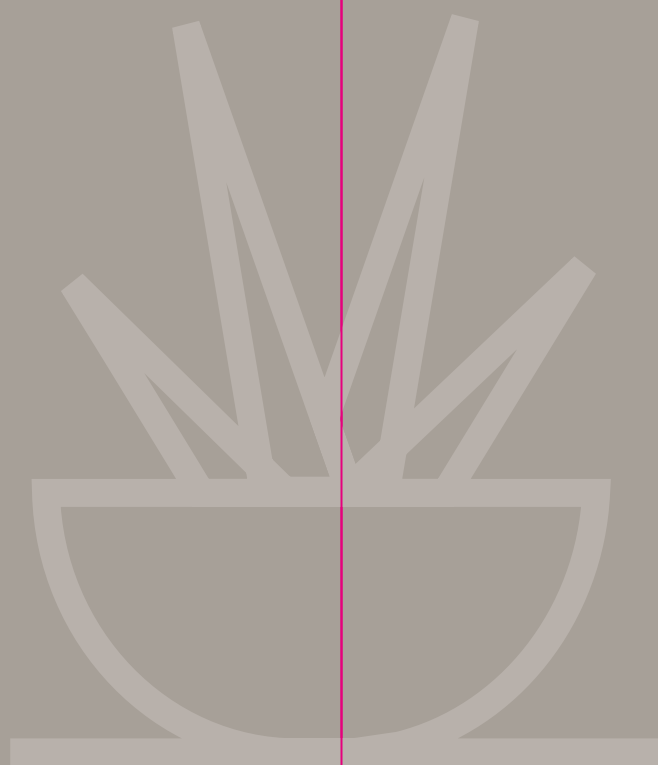

FIORIERE PLANTERS



INDEX

FIORIERE PLANTERS



G466

pag. 265



298GB

pag. 266



950-R

pag. 268



G516

pag. 272



G465

pag. 273



G465-BIS

pag. 273



379

pag. 270



439

pag. 270



974

pag. 271



D839C

pag. 274



G520

pag. 275



G489-BIS

pag. 275





Flora Big

G466

**FIORIERA CON SEDUTA /
PLANTER WITH SEATING**

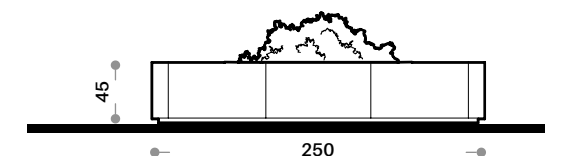
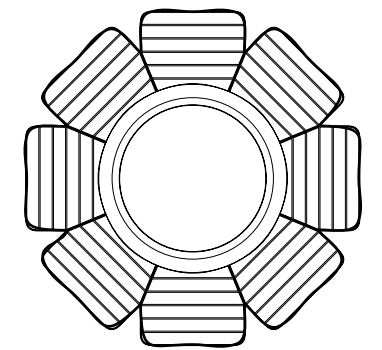

Designer	Gibillero Design
Dimensioni / Sizes	250x250 cm H 45 cm - 381 kg
Materiali / Materials	Acciaio zincato, Listoni in legno / Galvanized steel, Wooden planks
Fissaggio / Fixing	Predisposizione per tasselli / Predisposition for dowels





Clematis Grand Bouquet

298GB

FIORIERA CON SEDUTA /
PLANTER WITH SEATING

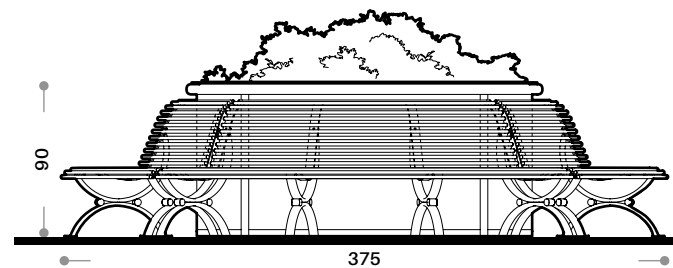

Designer	Dimcar Design Department
Dimensioni / Sizes	375x375 cm H 90 cm - 513 kg
Materiali / Materials	Acciaio zincato / Galvanized steel
Fissaggio / Fixing	Predisposizione per tasselli / Predisposition for dowels





Orchidea Maxi

950-R

**FIORIERA CON PARETI IN
LAMIERA FORATA /
PLANTER WITH PERFORATED
METAL SHEET PANELS**

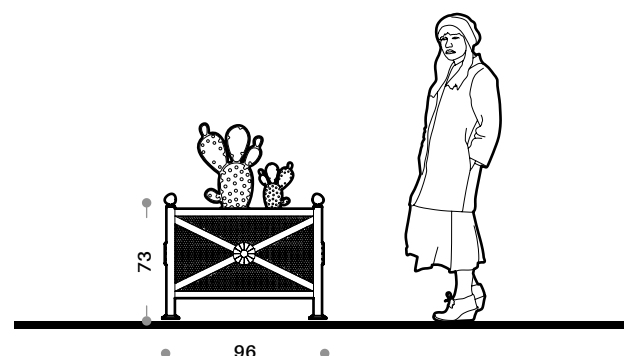

Designer	Dimcar Design Department
Dimensioni / Sizes	96x96 cm H 73 cm - 55 kg
Materiali / Materials	Acciaio zincato / Galvanized steel
Fissaggio / Fixing	Appoggio / Freestanding



Ermes

379

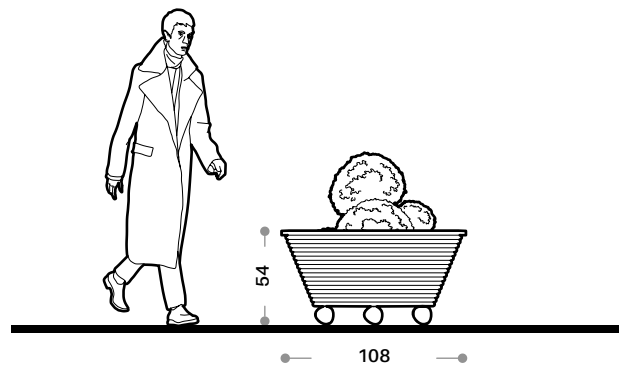

Designer	Dimcar Design Department
Dimensioni / Sizes	108x108 cm H 54 cm - 68 kg
Materiali / Materials	Acciaio zincato / Galvanized steel
Fissaggio / Fixing	Appoggio / Freestanding



Ozan

439

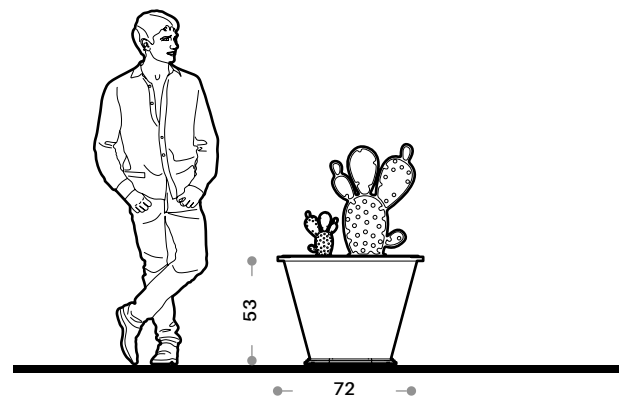

Designer	Dimcar Design Department
Dimensioni / Sizes	72x72 cm H 53 cm - 40 kg
Materiali / Materials	Acciaio zincato / Galvanized steel
Fissaggio / Fixing	Appoggio / Freestanding



Tulipano

974

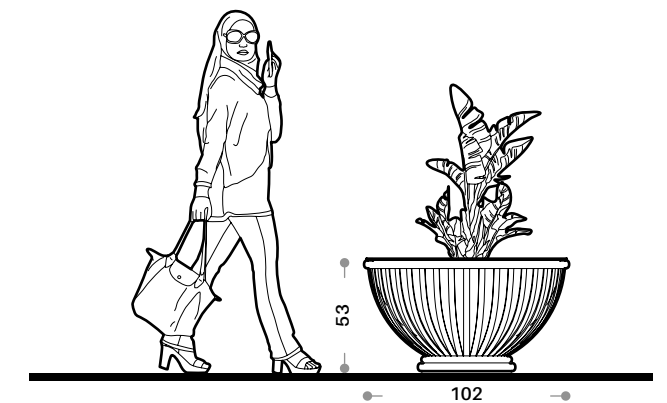

Designer	Dimcar Design Department
Dimensioni / Sizes	102x102 cm H 53 cm - 33 kg
Materiali / Materials	Acciaio zincato / Galvanized steel
Fissaggio / Fixing	Appoggio / Freestanding





Flea

G516

**FIORIERA CON FASCE IN OKUMÈ /
PLANTER WITH OKUME' WOODEN
PLANKS**

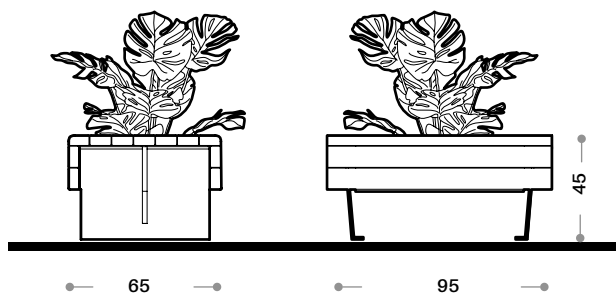

Designer	Gibillero Design
Dimensioni / Sizes	95x65 cm H 45 cm - 67 kg
Materiali / Materials	Acciaio zincato, Listoni in legno / Galvanized steel, Wooden planks
Fissaggio / Fixing	Predisposizione per tasselli / Predisposition for dowels

Flora alta

G465

**FIORIERA ALTA /
HIGH FLORA PLANTER**

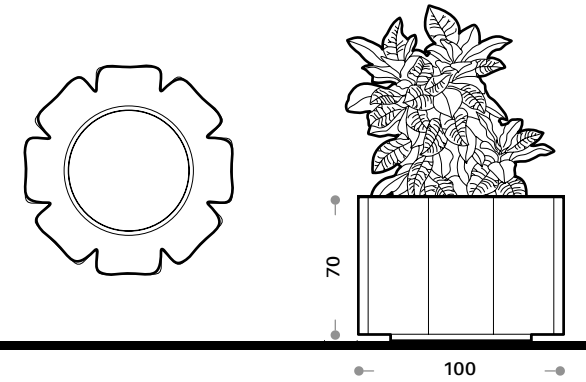

Designer	Gibillero Design
Dimensioni / Sizes	100x100 cm H 70 cm - 99 kg
Materiali / Materials	Acciaio zincato / Galvanized steel
Fissaggio / Fixing	Appoggio / Freestanding

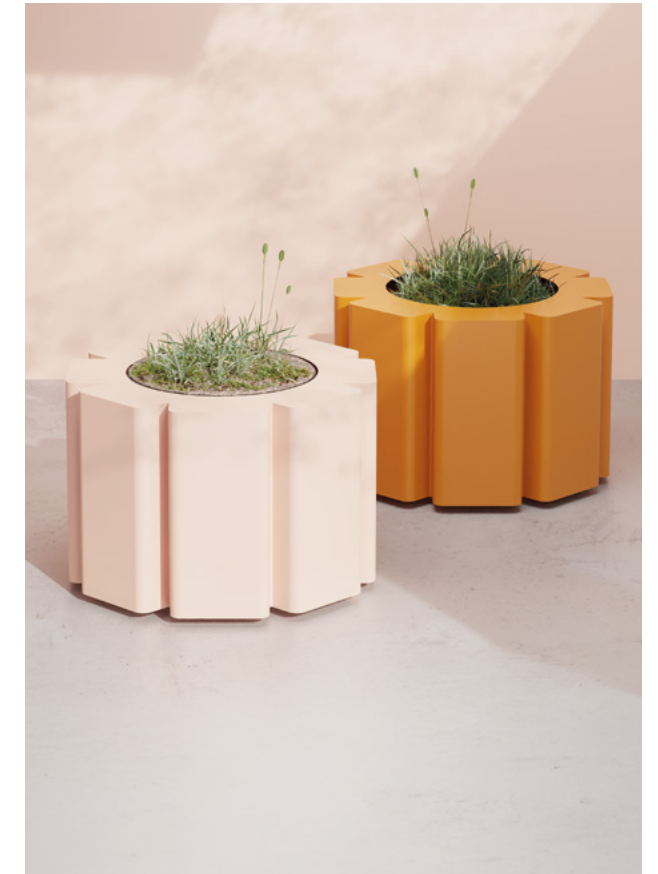

Flora bassa

G465-BIS

**FIORIERA BASSA /
LOW FLORA PLANTER**

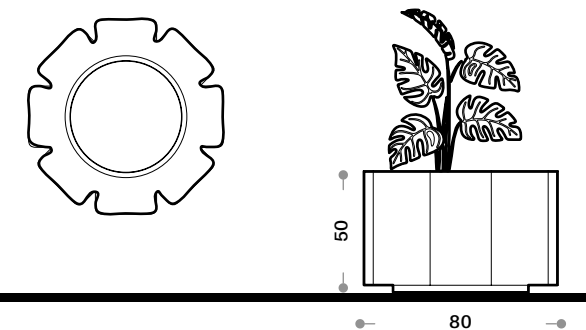

Designer	Gibillero Design
Dimensioni / Sizes	80x80 cm H 50 cm - 59 kg
Materiali / Materials	Acciaio zincato / Galvanized steel
Fissaggio / Fixing	Appoggio / Freestanding





Rusty

D839C

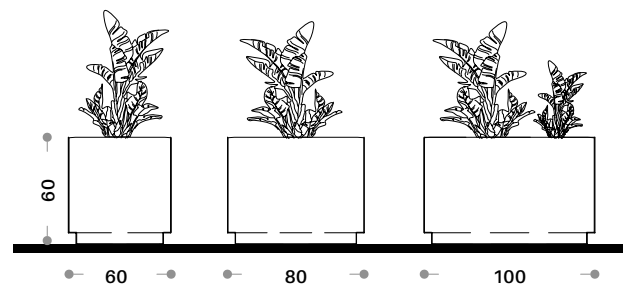

Designer	Dimcar Design Department
D839C Dimensioni / Sizes	60x60 80x80 100x100 cm H 60 cm - 37 - 57 - 74 kg
D839V Dimensioni / Sizes	60x60 80x80 100x100 cm H 60 cm - 40 - 57 - 80 kg
Materiali / Materials	Acciaio Corten / Corten Steel
Fissaggio / Fixing	Appoggio / Freestanding



Harry

G520

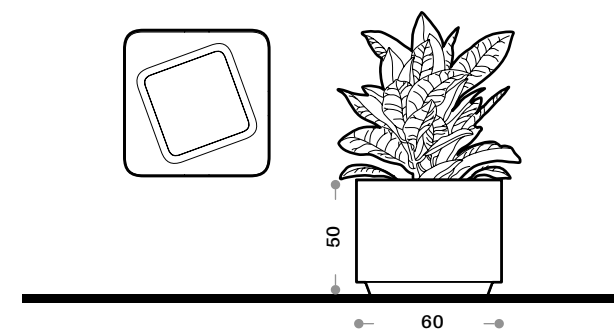

Designer	Gibillero Design
Dimensioni / Sizes	60x60 cm H 50 cm - 35 kg
Materiali / Materials	Acciaio zincato / Galvanized steel
Fissaggio / Fixing	Predisposizione per tasselli / Predisposition for dowels



Cubik bassa

G489-BIS

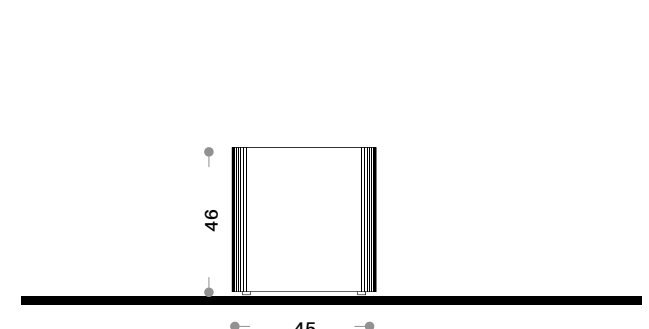

Designer	Gibillero Design
Dimensioni / Sizes	45x45 cm H 46 cm - 23 kg
Materiali / Materials	Acciaio zincato / Galvanized steel
Fissaggio / Fixing	Predisposizione per tasselli / Predisposition for dowels



PROTEGGI IL VERDE URBANO
CON SOLUZIONI DUREVOLI E
DECORATIVE.

*PROTECT URBAN GREENERY WITH DURABLE
AND DECORATIVE SOLUTIONS.*

GRIGLIE E SALVAPIANTE *TREE GRIDS AND GUARDS*





INDEX

GRIGLIE E SALVAPIANTE TREE GRIDS AND GUARDS



342
pag. 281



341
pag. 282



343
pag. 283



338
pag. 284



339
pag. 285

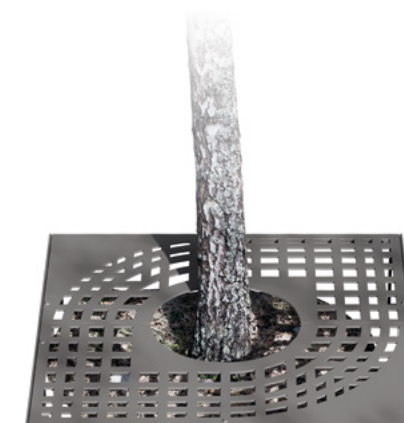

340
pag. 286

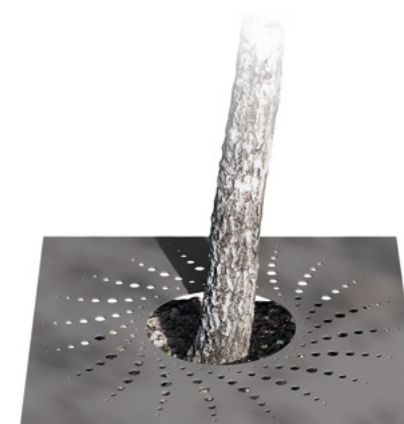

G526
pag. 288

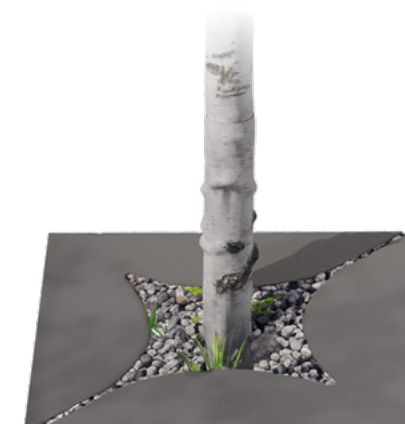

G527
pag. 289





Genziana

342

SALVAPIANTA / TREE PROTECTION



ø interno 30 cm
ø esterno max 55 cm

Internal diameter 30 cm
External diameter max 55 cm

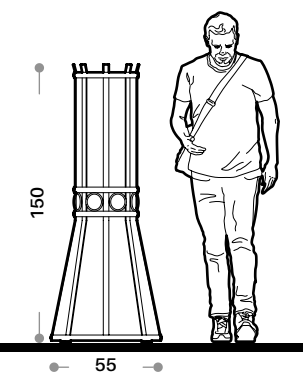

Designer	Dimcar Design Department
Dimensioni / Sizes	55x55 cm H 150 cm - 24 kg
Materiali / Materials	Acciaio zincato/ Galvanized steel
Fissaggio / Fixing	Predisposizione per tasselli / Predisposition for dowels



Anemone

341

SALVAPIANTA / TREE PROTECTION



ø interno 31 cm
ø esterno max 52 cm

Internal diameter 31 cm
External diameter max 52 cm

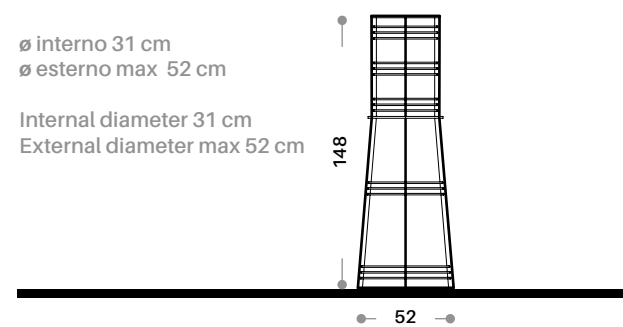

Designer Dimcar Design Department

Dimensioni / Sizes 52x52 cm H 148 cm - 21 kg

Materiali / Materials Acciaio zincato/
Galvanized steel

Fissaggio / Fixing Predisposizione per tasselli /
Predisposition for dowels



Biancospino

343

SALVAPIANTA / TREE PROTECTION



ø interno 30 cm
ø esterno max 50 cm

Internal diameter 30 cm
External diameter max 50 cm

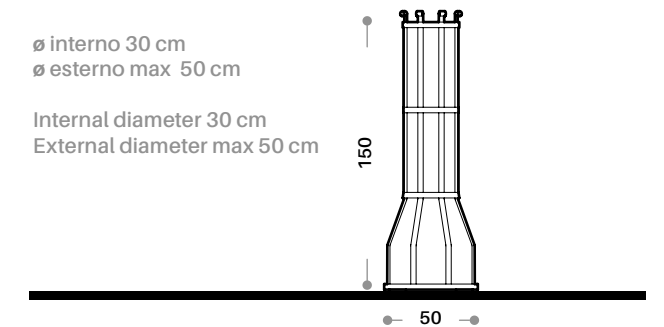

Designer Dimcar Design Department

Dimensioni / Sizes 50x50 cm H 150 cm - 18 kg

Materiali / Materials Acciaio zincato/
Galvanized steel

Fissaggio / Fixing Predisposizione per tasselli /
Predisposition for dowels



Dafne

338

GRIGLIA / GRID

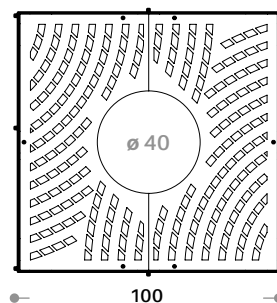

Designer	Dimcar Design Department
Dimensioni / Sizes	100x100 cm H 3 cm - 41 kg
Materiali / Materials	Acciaio zincato / Galvanized steel
Fissaggio / Fixing	Predisposizione per tasselli / Predisposition for dowels

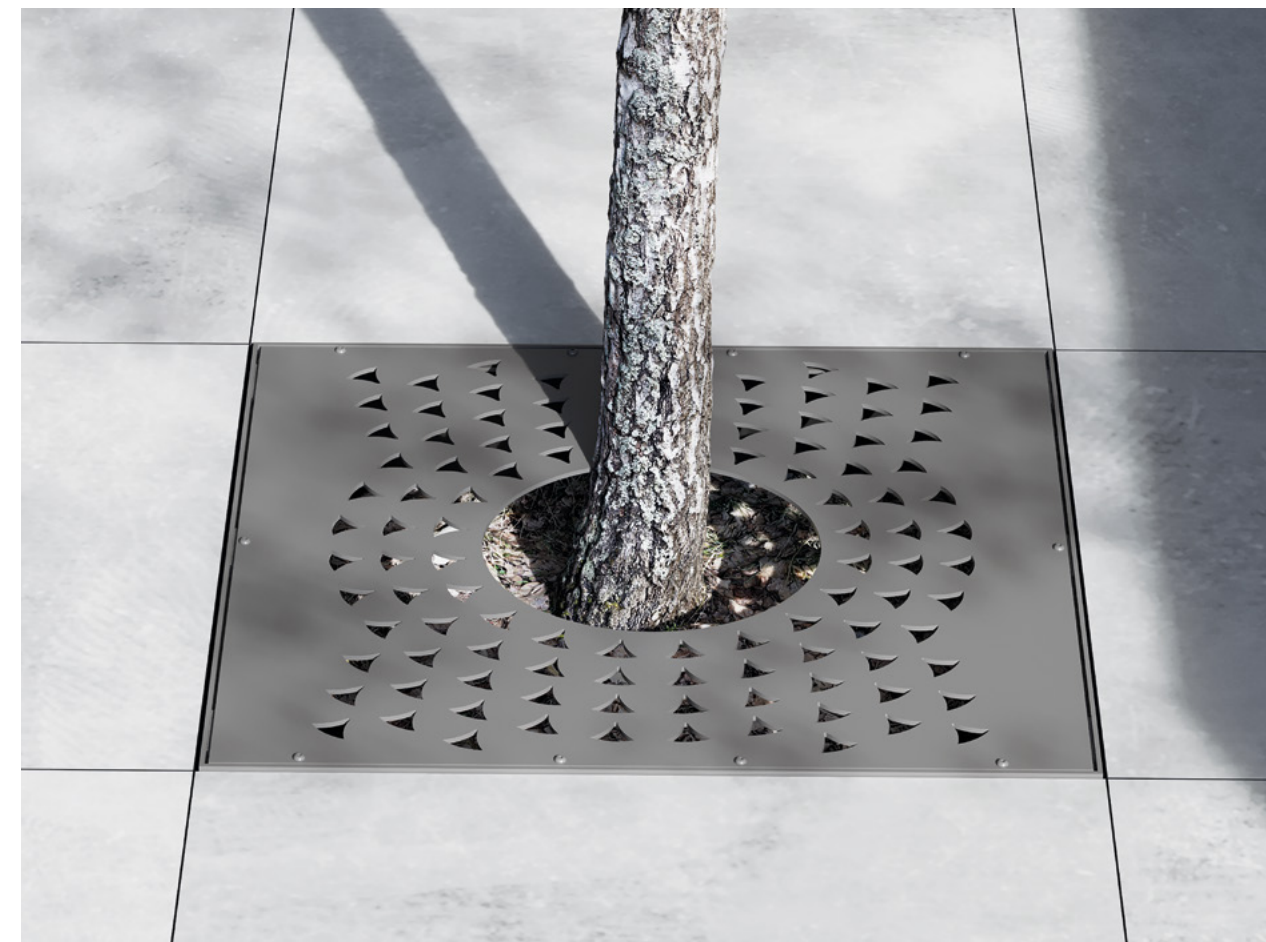

Millefoglie

339

GRIGLIA / GRID

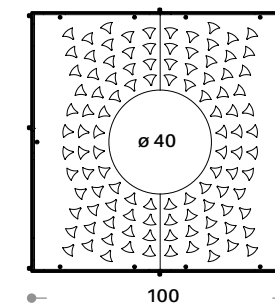

Designer	Dimcar Design Department
Dimensioni / Sizes	100x100 cm H 3 cm - 45 kg
Materiali / Materials	Acciaio zincato / Galvanized steel
Fissaggio / Fixing	Predisposizione per tasselli / Predisposition for dowels



Primula

340

GRIGLIA / GRID

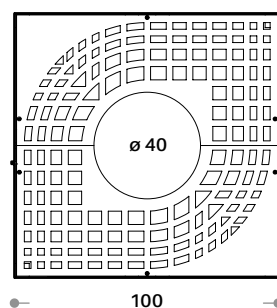

Designer	Dimcar Design Department
Dimensioni / Sizes	100x100 cm H 3 cm - 40 kg
Materiali / Materials	Acciaio zincato / Galvanized steel
Fissaggio / Fixing	Predisposizione per tasselli / Predisposition for dowels





Scirocco

G526

GRIGLIA / GRID

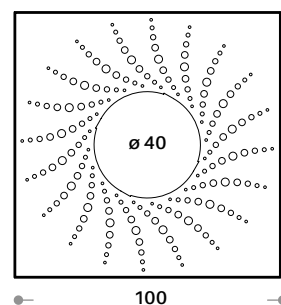

Designer	Gibillero
Dimensioni / Sizes	100x100 cm H 3 cm - 46 kg
Materiali / Materials	Acciaio zincato / Galvanized steel
Fissaggio / Fixing	Predisposizione per tasselli / Predisposition for dowels

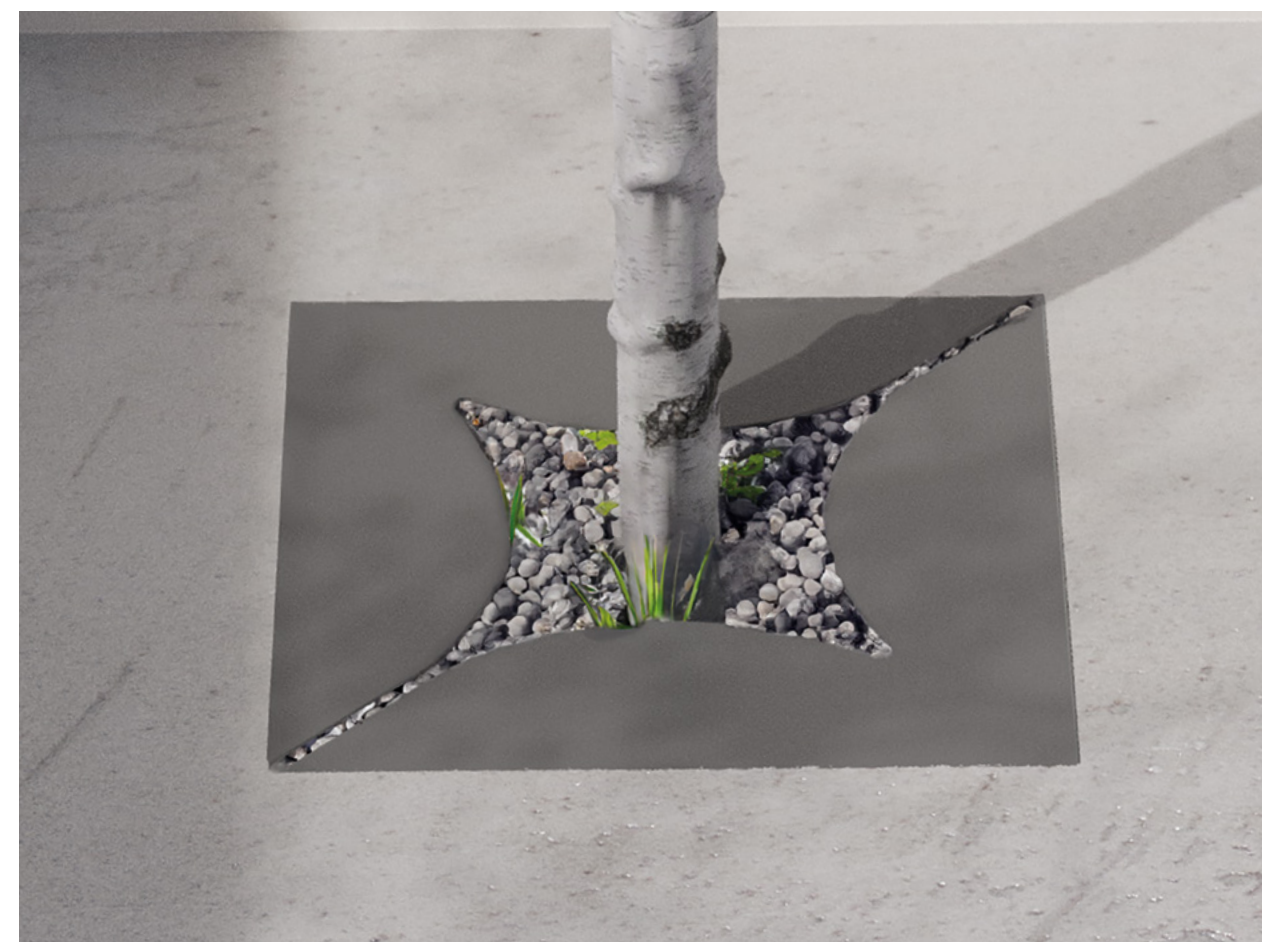

Star

G527

GRIGLIA / GRID

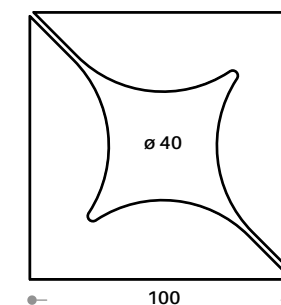

Designer	Gibillero
Dimensioni / Sizes	100x100 cm H 3 cm - 44 kg
Materiali / Materials	Acciaio zincato / Galvanized steel
Fissaggio / Fixing	Predisposizione per tasselli / Predisposition for dowels

NON È SOLO METALLO: SONO
VITE, SOGNI E STORIE CHE
SI SALDANO.
IN OGNI SCINTILLA, UN
FRAMMENTO DI FUTURO
PRENDE FORMA.

*WELDING METAL IS NOT JUST ABOUT
METAL; IT'S ALSO ABOUT LIVES,
DREAMS, AND STORIES THAT ARE
BONDED TOGETHER.
EACH SPARK REVEALS A FRAGMENT
OF THE FUTURE.*



GESTISCI GLI ACCESSI E
PROTEGGI GLI SPAZI CON
STILE E FUNZIONALITÀ.



*MANAGE ACCESS AND PROTECT SPACES WITH
STYLE AND FUNCTIONALITY.*

PARAPEDONI *CITY BARRIERS*



INDEX

PARAPEDONI CITY BARRIERS



612

pag. 296



611

pag. 298



610

pag. 299



614

pag. 300



955

pag. 301



300

pag. 302



300-BIS

pag. 302



351

pag. 303



352

pag. 303

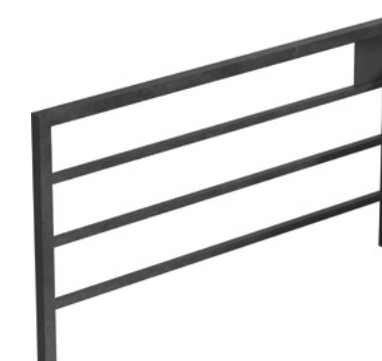

405

pag. 304



405-BIS

pag. 305





Tau

612

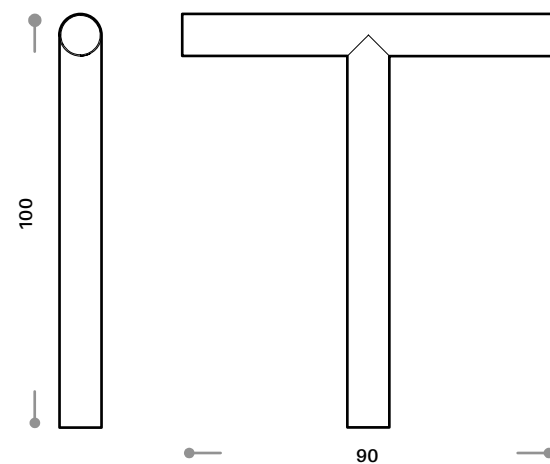

Designer	Dimcar Design Department
Dimensioni / Sizes	90x10,2 cm H 100 cm - 19 kg
Materiali / Materials	Acciaio zincato/ Galvanized steel
Fissaggio / Fixing	Cementazione / Cementation





UpsideDown

611-L / 611-S



611-L



611-S

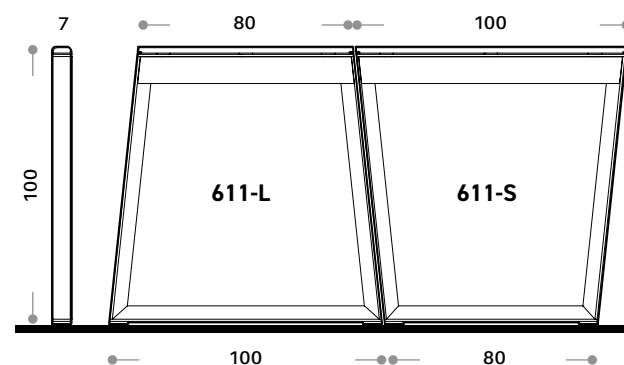

Designer	Dimcar Design Department
Dimensioni / Sizes	100x7 cm H 100 cm - 22 kg
Materiali / Materials	Acciaio zincato / Galvanized steel
Fissaggio / Fixing	Cementazione / Cementation



Zen

610

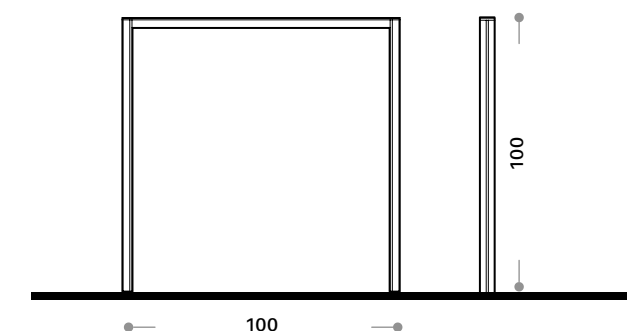

Designer	Dimcar Design Department
Dimensioni / Sizes	100x6 cm H 100 cm - 20 kg
Materiali / Materials	Acciaio zincato / Galvanized steel
Fissaggio / Fixing	Cementazione / Cementation





Ciak

614-L / 614-G / 614-A

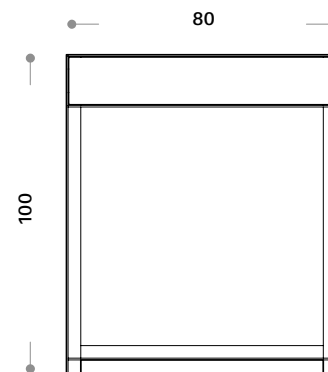

Designer	Dimcar Design Department
614-L Dimensioni / Sizes	80x8 cm H 100 cm - 26 kg
614-G Dimensioni / Sizes	80x8 cm H 100 cm - 30 kg
614-A Dimensioni / Sizes	80x8 cm H 100 cm - 29 kg
Materiali / Materials	Acciaio zincato / Galvanized steel
Fissaggio / Fixing	Cementazione / Cementation



Open&Go

955

OPEN&GO BARRIER WITH BARRICADE OF 90CM

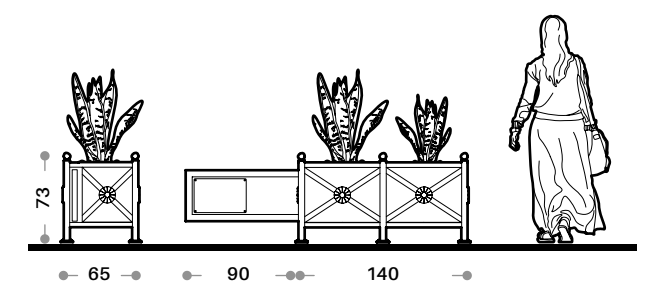

Designer	Dimcar Design Department
Dimensioni / Sizes	140x65 cm H 73 cm - 68 kg
Materiali / Materials	Acciaio zincato / Galvanized steel
Fissaggio / Fixing	Predisposizione per tasselli / Predisposition for dowels



Walk

300

TRANSENNA PARAPEDONE /
PEDESTRAIN PROTECTION BARRIER



City

300-BIS

TRANSENNA PARAPEDONE
PUBBLICITARIA /
PEDESTRAIN PROTECTION BARRIER
WITH ADVERTISING BOARD



Designer Dimcar Design Department

Dimensioni / Sizes 100X6 cm H 105 cm - 15 kg

Materiali / Materials Acciaio zincato/
Galvanized steel

Fissaggio / Fixing Cementazione / Cementation

Designer Dimcar Design Department

Dimensioni / Sizes 100X6 cm H 105 cm - 15 kg

Materiali / Materials Acciaio zincato/
Galvanized steel

Fissaggio / Fixing Cementazione / Cementation



Palermo

351

TRANSENNA PARAPEDONE /
PEDESTRAIN PROTECTION BARRIER



Palermo

352

TRANSENNA PARAPEDONE
PUBBLICITARIA /
PEDESTRAIN PROTECTION BARRIER
WITH ADVERTISING BOARD

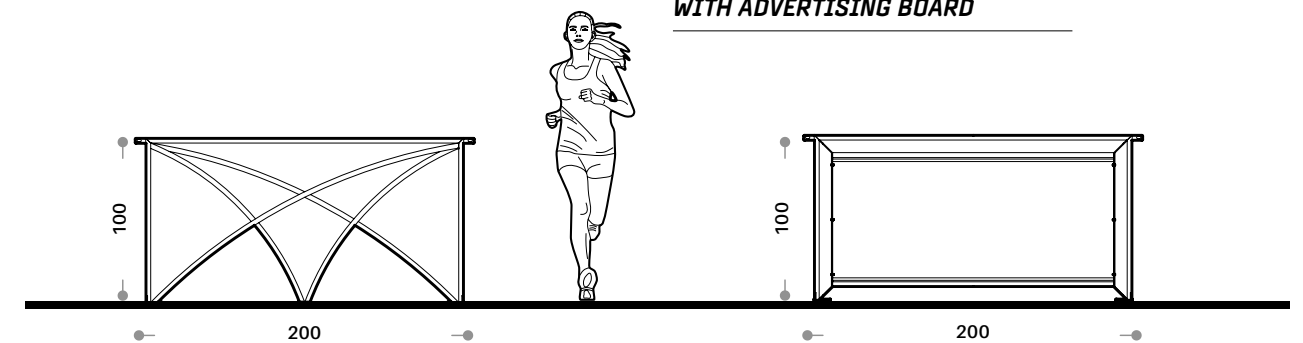

Designer Dimcar Design Department

Dimensioni / Sizes 200x17 cm H 100 cm - 14 kg

Materiali / Materials Acciaio zincato/
Galvanized steel

Fissaggio / Fixing Predisposizione per tasselli /
Predisposition for dowels

Designer Dimcar Design Department

Dimensioni / Sizes 200x17 cm H 100 cm - 28 kg

Materiali / Materials Acciaio zincato/
Galvanized steel

Fissaggio / Fixing Predisposizione per tasselli /
Predisposition for dowels



Simply

405

**TRANSENNA PARAPEDONE /
PEDESTRAIN PROTECTION BARRIER**

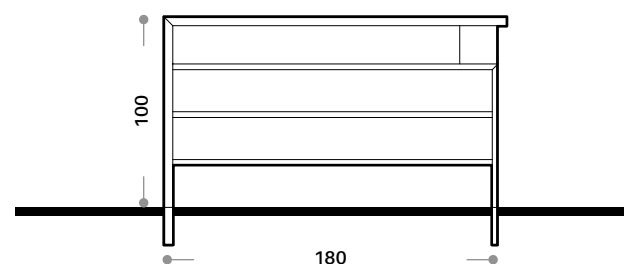

Designer	Dimcar Design Department
Dimensioni / Sizes	180x5 cm H 100 cm - 16 kg
Materiali / Materials	Acciaio zincato / Galvanized steel
Fissaggio / Fixing	Cementazione / Cementation



Simply

405-BIS

**TRANSENNA PARAPEDONE
PUBBLICITARIA /
PEDESTRAIN PROTECTION BARRIER
WITH ADVERTISING BOARD**

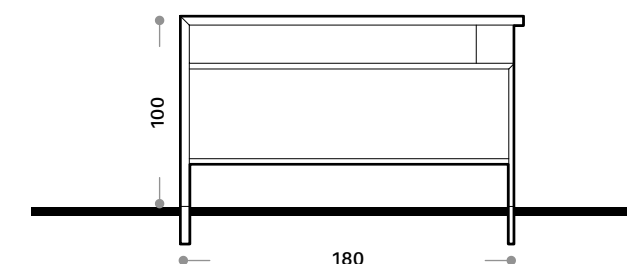

Designer	Dimcar Design Department
Dimensioni / Sizes	180x5 cm H 100 cm - 24 kg
Materiali / Materials	Acciaio zincato / Galvanized steel
Fissaggio / Fixing	Cementazione / Cementation





PROTEGGI GLI SPAZI URBANI
CON DISSUASORI ROBUSTI
DAL DESIGN CURATO E
FUNZIONALE.



*ENSURE THE SAFETY OF URBAN SPACES WITH
STRONG BOLLARDS AND WITH A FUNCTIONAL
AND WELL-MAINTAINED DESIGN.*

DISSUASORI *BOLLARDS*

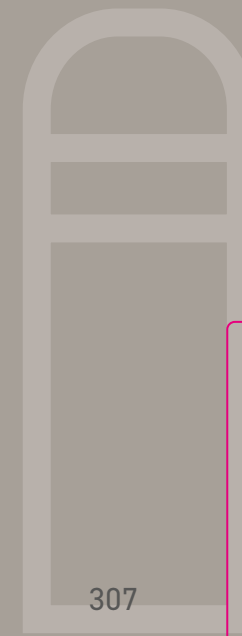
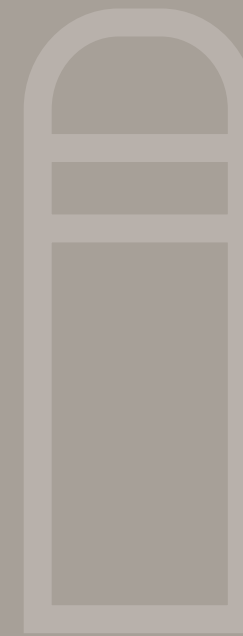
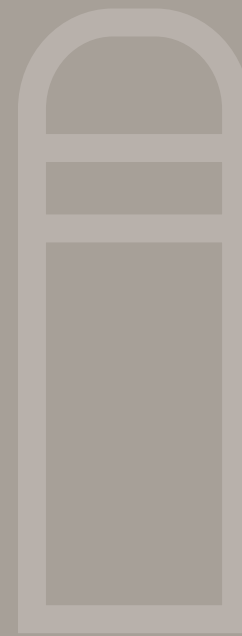
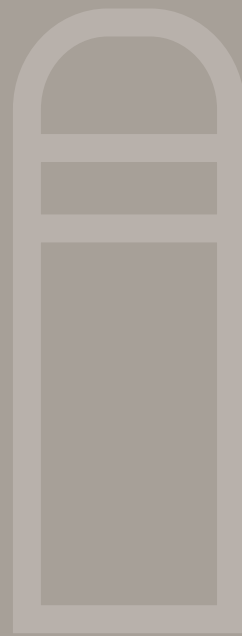
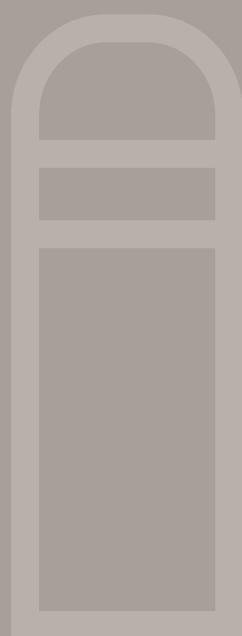
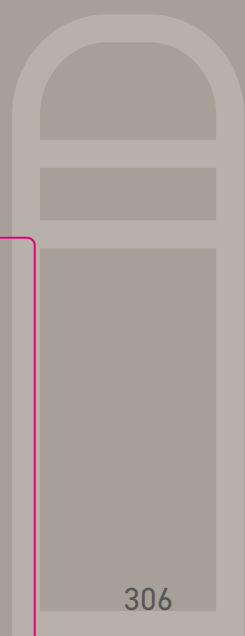

Disuasori
Bollards



INDEX

DISSUASORI BOLLARDS



609
pag. 310



612-D
pag. 313



227-BIS
pag. 314



G479
pag. 316



G478
pag. 316



601
pag. 317



227
pag. 314



396
pag. 315



232
pag. 315



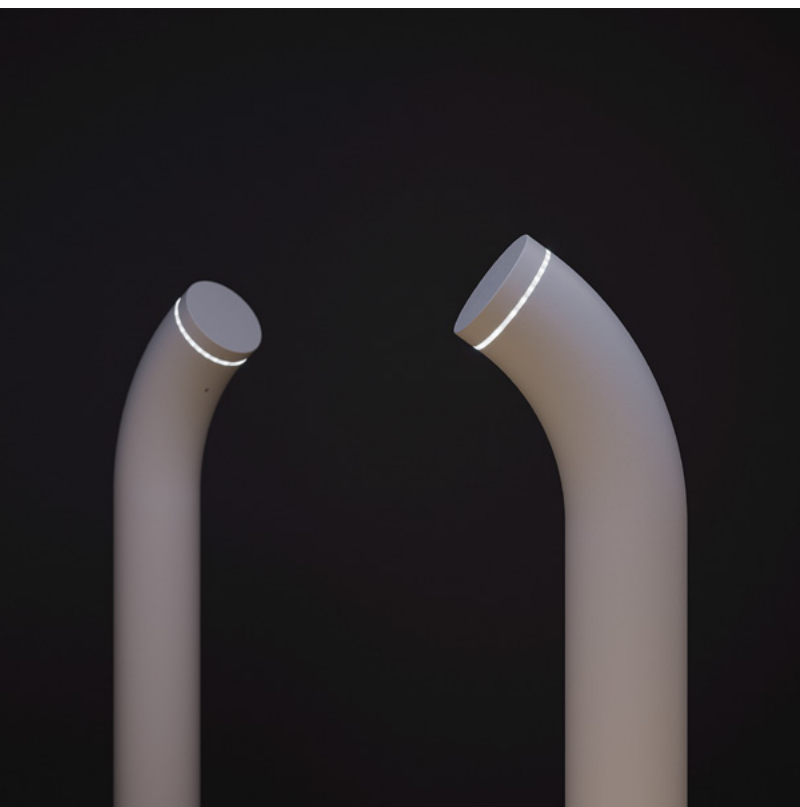

Bow

609

COMPLETO DI ILLUMINAZIONE /
COMPLETE WITH LIGHTING

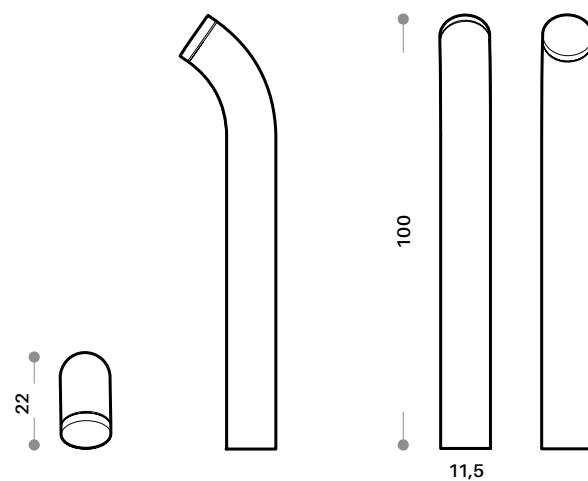

Designer	Dimcar Design Department
Dimensioni / Sizes	22x11,5 cm H 100 cm - 12 kg
Materiali / Materials	Acciaio zincato / Galvanized steel
Fissaggio / Fixing	Cementazione / Cementation



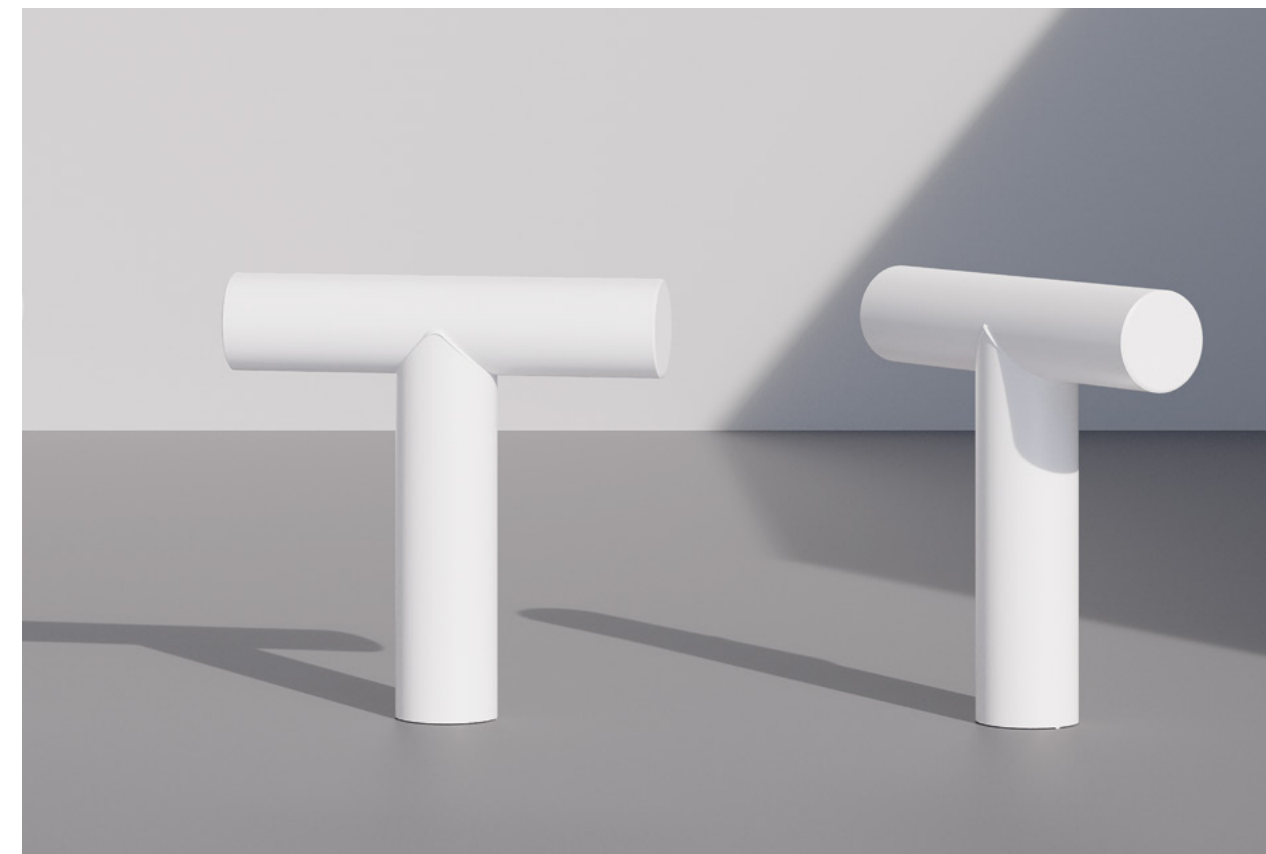

Tau

612-D

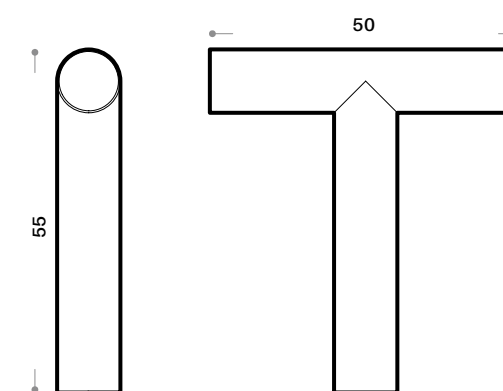

Designer	Dimcar Design Department
Dimensioni / Sizes	50x10,2 cm H 55 cm - 12 kg
Materiali / Materials	Acciaio zincato / Galvanized steel
Fissaggio / Fixing	Cementazione / Cementation





Icaro

227-BIS



227

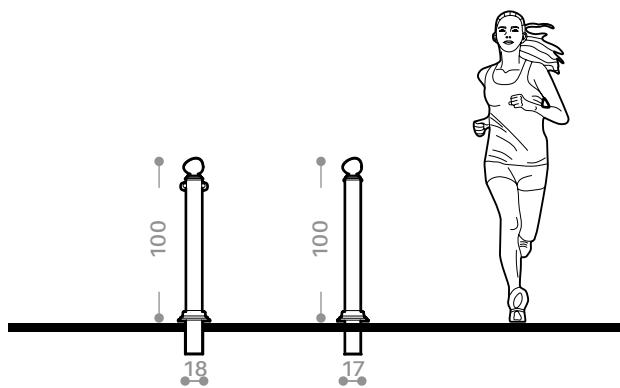

Designer	Dimcar Design Department
Dimensioni / Sizes	18x18 cm H 100 cm - 7 kg
Materiali / Materials	Acciaio zincato / Galvanized steel
Fissaggio / Fixing	Cementazione / Cementation
Optional / Optional	Sistema di amovibilità / Removable system



Roller

396

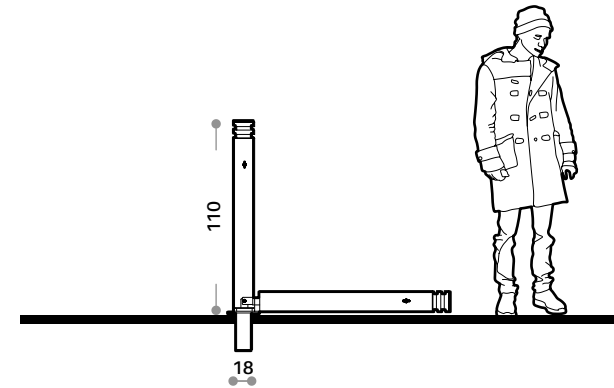

Designer	Dimcar Design Department
Dimensioni / Sizes	18x18 cm H 110 cm - 17 kg
Materiali / Materials	Acciaio zincato / Galvanized steel
Fissaggio / Fixing	Cementazione / Cementation
Optional / Optional	Sistema di amovibilità / Removable system



Stilo

232

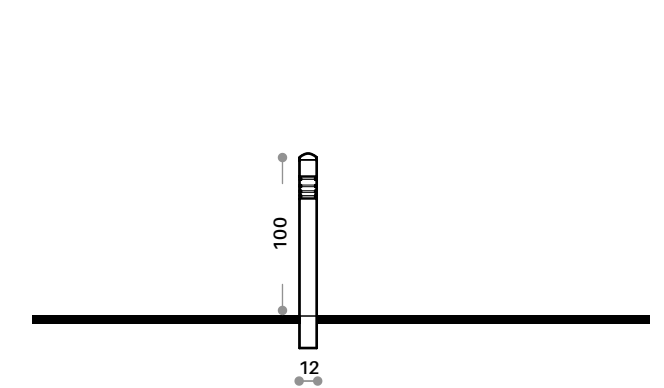

Designer	Dimcar Design Department
Dimensioni / Sizes	12x12 cm H 100 cm - 13 kg
Materiali / Materials	Acciaio zincato / Galvanized steel
Fissaggio / Fixing	Cementazione / Cementation
Optional / Optional	Sistema di amovibilità / Removable system





Oliver

G479

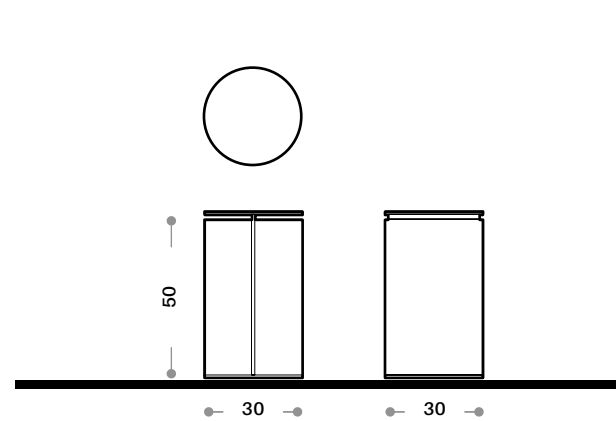

Designer	Gibillero Design
Dimensioni / Sizes	30x30 cm H 50 cm - 39 kg
Materiali / Materials	Acciaio zincato / Galvanized steel
Fissaggio / Fixing	Cementazione / Cementation



Stanley

G478

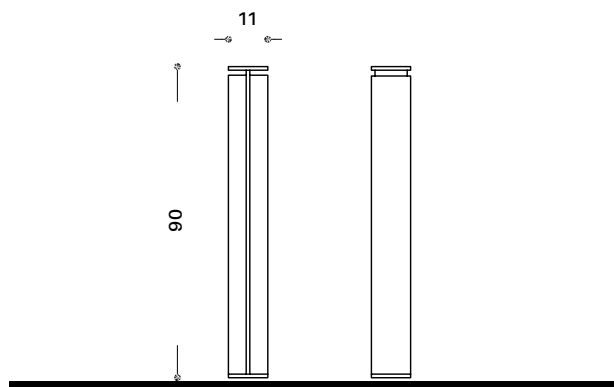

Designer	Gibillero Design
Dimensioni / Sizes	11x11 cm H 90 cm - 17 kg
Materiali / Materials	Acciaio zincato / Galvanized steel
Fissaggio / Fixing	Cementazione / Cementation



Pin

601

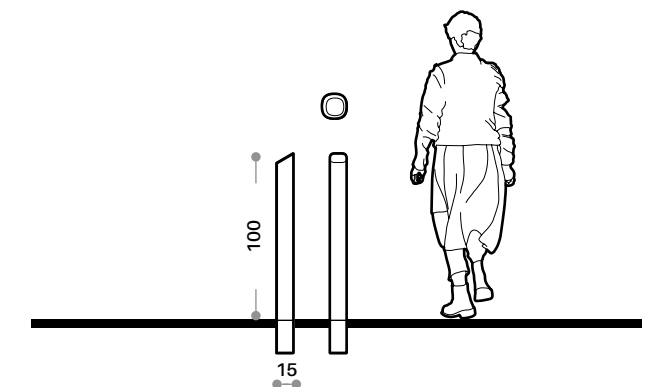

Designer	Dimcar Design Department
Dimensioni / Sizes	15x15 cm H 100 cm - 6 kg
Materiali / Materials	Acciaio inox / Stainless steel
Fissaggio / Fixing	Cementazione / Cementation
Optional / Optional	Sistema di amovibilità / Removable system



FORNISCI INFORMAZIONI
CHIARE E ACCESSIBILI CON
STRUTTURE ELEGANTI.

*PROVIDE CLEAR AND ACCESSIBLE
INFORMATION WITH ELEGANT STRUCTURES.*



**SUPPORTI
INFORMATIVI**
*OUTDOOR NOTICE
BOARDS*



INDEX

SUPPORTI INFORMATIVI OUTDOOR NOTICE BOARDS



G529

pag. 322



G459

pag. 323



G536

pag. 323



446

pag. 326



184

pag. 327



276

pag. 328

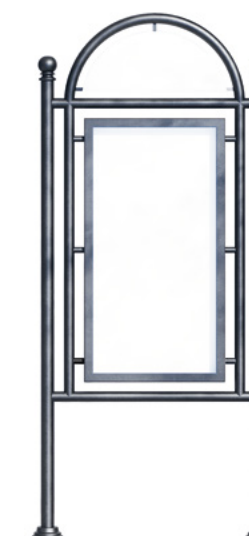

191

pag. 324



281

pag. 324



254

pag. 325



215

pag. 329





YouAreHere

G529

TOTEM / TOTEM

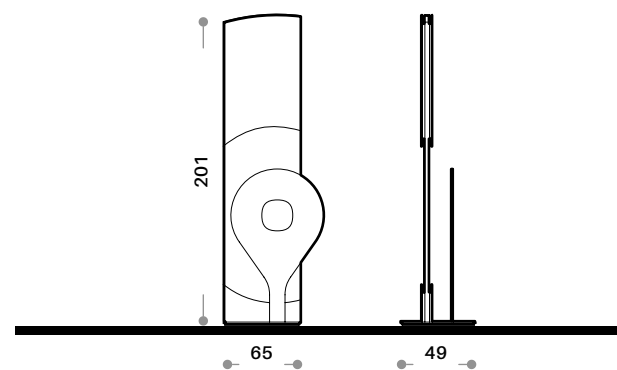

Designer	Gibillero Design
Dimensioni / Sizes	65x49 cm H 201 cm - 99 kg
Materiali / Materials	Acciaio zincato / Galvanized steel
Fissaggio / Fixing	Predisposizione per tasselli / Predisposition for dowels



Phil

G459

TOTEM / TOTEM

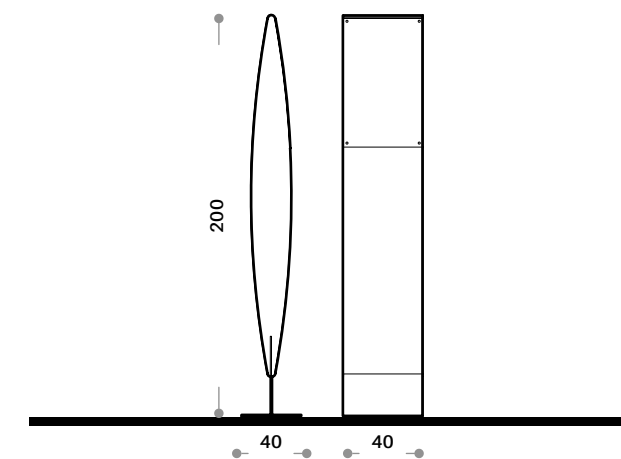

Designer	Gibillero Design
Dimensioni / Sizes	40x40 cm H 200 cm - 55 kg
Materiali / Materials	Acciaio zincato/ Galvanized steel
Fissaggio / Fixing	Predisposizione per tasselli / Predisposition for dowels



PopUp

G536

TOTEM / TOTEM

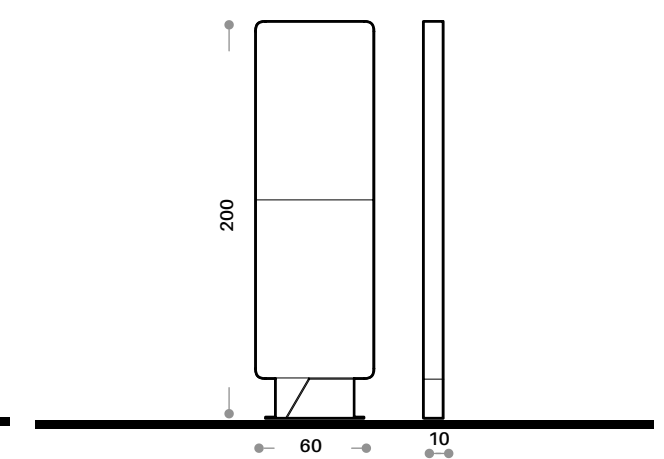

Designer	Gibillero Design
Dimensioni / Sizes	60x10 cm H 200 cm - 66 kg
Materiali / Materials	Acciaio zincato/ Galvanized steel
Fissaggio / Fixing	Predisposizione per tasselli / Predisposition for dowels



Archè

191

LEGGIO / LECTERN

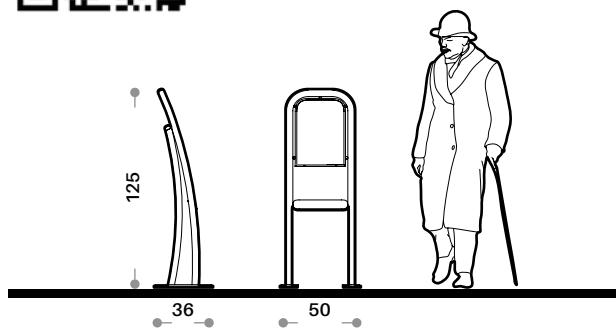

Designer Dimcar Design Department

Dimensioni / Sizes 50x36 cm H 125 cm - 16 kg

Materiali / Materials Acciaio zincato / Galvanized steel

Fissaggio / Fixing Predisposizione per tasselli / Predisposition for dowels



Sinuo

281

LEGGIO / LECTERN

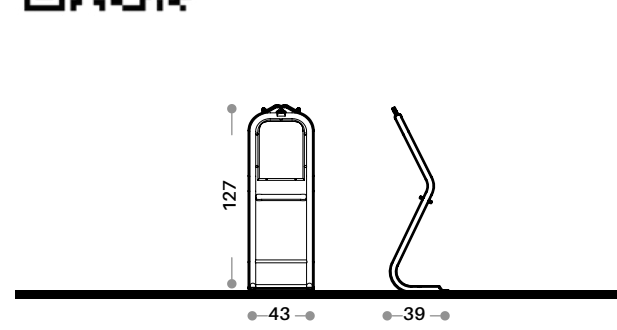

Designer Dimcar Design Department

Dimensioni / Sizes 43x39 cm H 127 cm - 10 kg

Materiali / Materials Acciaio zincato / Galvanized steel

Fissaggio / Fixing Predisposizione per tasselli / Predisposition for dowels



Barocco

254

LEGGIO / LECTERN

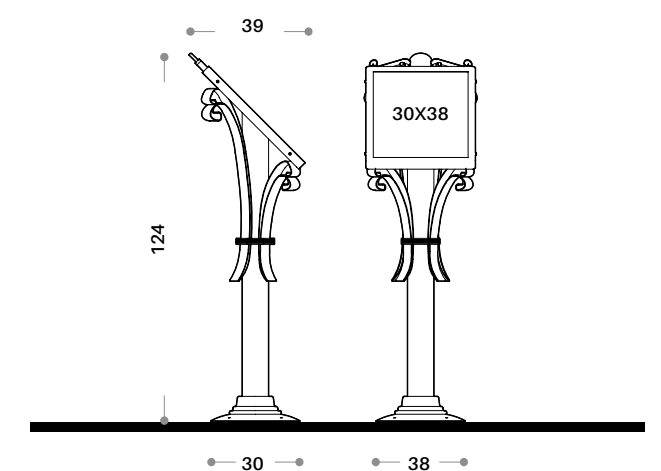

Designer Dimcar Design Department

Dimensioni / Sizes 38x39 cm H 124 cm - 16 kg

Materiali / Materials Acciaio zincato / Galvanized steel

Fissaggio / Fixing Predisposizione per tasselli / Predisposition for dowels



Temporary

446

TABELLONE PER FERMATA BUS /
TIMETABLE TABLE FOR BUS STOPS

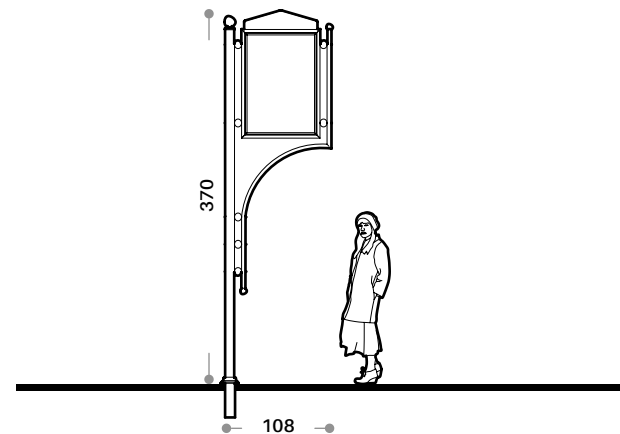

Designer	Dimcar Design Department
Dimensioni / Sizes	108x17 cm H 370 cm - 61 kg
Materiali / Materials	Acciaio zincato / Galvanized steel
Fissaggio / Fixing	Cementazione / Cementation



Informativo

184

TABELLONE / INFORMATION POST

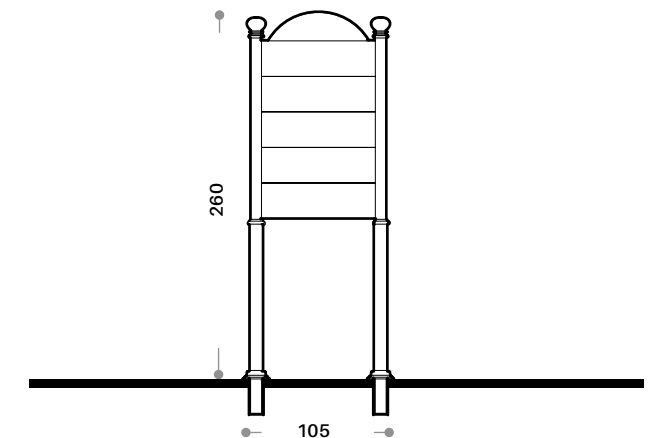

Designer	Dimcar Design Department
Dimensioni / Sizes	105x17 cm H 260 cm - 45 kg
Materiali / Materials	Acciaio zincato / Galvanized steel
Fissaggio / Fixing	Cementazione / Cementation





Athena

276

BACHECA / BULLETIN BOARD

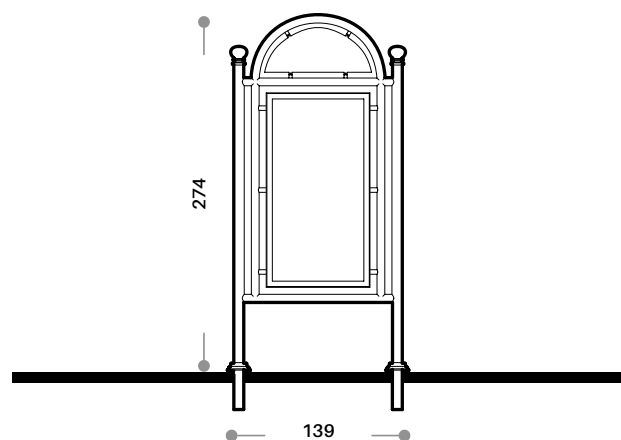

Designer	Dimcar Design Department
Dimensioni / Sizes	139x17 cm H 274 cm - 77 kg
Materiali / Materials	Acciaio zincato / Galvanized steel
Fissaggio / Fixing	Cementazione / Cementation



Visual

215

TABELLONE / BULLETIN BOARD

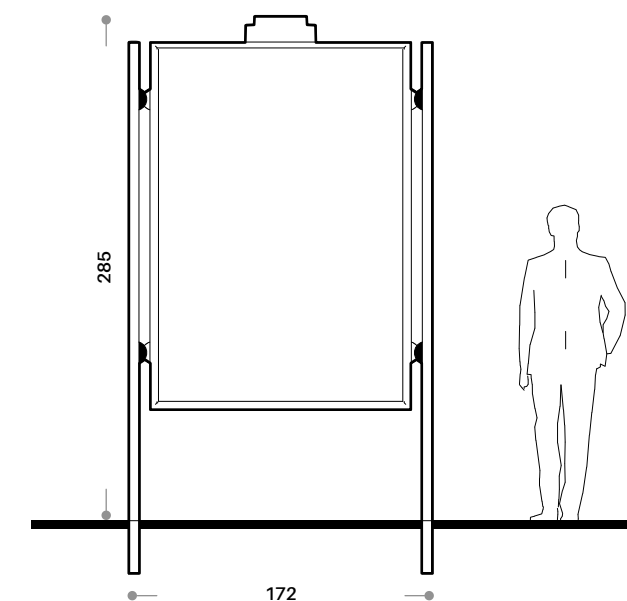

Designer	Dimcar Design Department
Dimensioni / Sizes	172x6 cm H 285 cm - 58 kg
Materiali / Materials	Acciaio zincato / Galvanized steel
Fissaggio / Fixing	Cementazione / Cementation





RENDI GLI SPAZI PUBBLICI
ACCOGLIENTI CON FONTANE
FUNZIONALI E DAL DESIGN
RICERCATO.



*MAKE PUBLIC SPACES WELCOMING WITH
FUNCTIONAL FOUNTAINS AND REFINED DESIGN.*



FONTANE
*DRINKING
FOUNTAINS*



INDEX

FONTANE FOUNTAINS



D859



pag.333



You&Me

D859

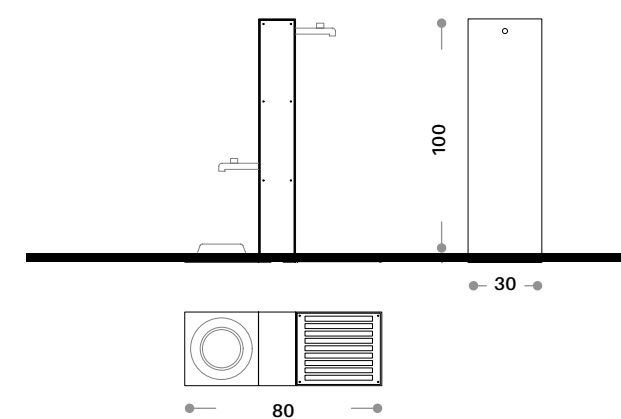

Designer	Dimcar Design Department
Dimensioni / Sizes	80X30 cm H 100 cm - 33 kg
Materiali / Materials	Acciaio zincato / Galvanized steel
Fissaggio / Fixing	Predisposizione per tasselli / Predisposition for dowels





DOMATO DA MANI SAPIENTI,
L'ACCIAIO PRENDE VITA.
DIVENTA FORMA, FORZA
E RESISTENZA PRONTA A
INCONTRARE IL MONDO.

*STEEL IS BROUGHT TO LIFE BY
WISE HANDS.
BECOME FIT, POWERFUL, AND
PREPARED TO FACE THE WORLD.*

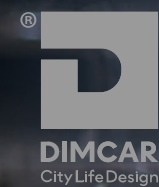

CONTENTS

pag. 338

LINEA IO
LINEA IO

pag. 340

LINEA NOI
LINEA NOI

pag. 342

LINEA KOMETE
LINEA KOMETE

pag. 344

LINEA PINCH
LINEA PINCH

pag. 346

LINEA URBAN BABY
LINEA URBAN BABY

pag. 350

PENSILINE E COPERTURE
*BUS SHELTERS AND
CANOPIES*

pag. 358

RASTRELLIERE PORTABICI
BIKE RACKS

pag. 358

CICLOSTAZIONI
BIKE STATIONS

pag. 364

PANCHINE DA ESTERNO
OUTDOOR BENCHES

pag. 370

PANCHE
SEATINGS

pag. 376

**CESTONI PORTARIFIUTI
DA ESTERNO**
OUTDOOR LARGE TRASH BINS

pag. 380

**CESTINI PORTARIFIUTI
DA ESTERNO**
OUTDOOR LITTER BINS

pag. 386

**CESTINI E CESTONI
RACCOLTA DIFFERENZIATA**
*OUTDOOR RECYCLING
LITTER BINS*

pag. 391

POSACENERE
OUTDOOR ASHTRAYS

pag. 394

TAVOLI DA PICNIC
PICNIC TABLES

pag. 396

FIORIERE
PLANTERS

pag. 400

GRIGLIE E SALVAPIANTE
TREE GRIDS AND GUARDS

pag. 401

PARAPEDONI
CITY BARRIERS

pag. 404

DISSUASORI
BOLLARDS

pag. 416

SUPPORTI INFORMATIVI
OUTDOOR NOTICE BOARDS

pag. 421

FONTANE
DRINKING FOUNTAINS



604-CO-L

Cestino io con rivestimento in legno

pag. 33



604-CO-M

Cestino io con rivestimento in metallo

pag. 33



604-EL-C

Elemento di collegamento curvo



604-PE-3-COMP1

Pensilina io 3 moduli

pag. 24



604-PE-4-COMP1

Pensilina io 4 moduli

pag. 26



604-PE-0-PC

Pensilina io optional panca corta

pag. 31



604-EL-Q

Elemento di collegamento quadrato



604-FIO-090

Fioriera io da cm. 90x50

pag. 32



604-FIO-110

Fioriera io da cm. 110x50

pag. 32



604-PE-0-PL

Pensilina io optional panca lunga

pag. 31

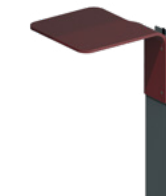

604-PE-0-T

Pensilina io optional tavolino

pag. 31



604-PE-0-V

Pensilina io optional parete laterale vetrata

pag. 31



604-FIO-135

Fioriera io da cm. 135x50

pag. 32



604-PA

Panca io

pag. 31



604-PE-2-COMP1

Pensilina io 2 moduli

pag. 22



604-SOL

Modulo solare

pag. 31





606-CE
Cestone Noi
pag. 48





606-M
Seduta Noi
pag. 45



606-M-F
Fioriera Noi
pag. 46





606-PE-0-P
Pensilina Noi optional
panca



606-PE-0-V
Pensilina Noi optional
parete laterale vetrata



606-PO
Portabici
pag. 47



606-M-R
Seduta Noi con rastrel-
liera
pag. 46



606-M-S
Seduta Noi con schie-
nale e ricarica USB
pag. 45





606-M-SF
Seduta Noi con fioriera
pag. 46





606-M-SL
Seduta Noi con schie-
nale
pag. 45



606-PE-COMP1
Pensilina Noi
pag. 40



606-PE-D-COMP1
Pensilina Noi doppia
pag. 42





D818
Pensilina Komete
pag. 56



D818-B
Pensilina Komete con
bacheca



D818-S
Pensilina Komete Solar
pag. 58



D822
Cestino Komete
pag. 62



D822-BIS
Cestino Komete con
coperchio e posacenere



D823
Posacenere Komete



D818-S-B
Pensilina Komete Solar
con bacheca



D819
Panca Komete
pag. 61



D819-BIS
Panchina Komete
pag. 60



D824
Portabici Komete
pag. 63

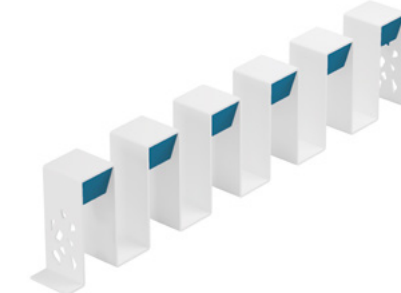

D825
Rastrelliera Komete
pag. 63



D861
Bike box Komete



D820
Fioriera Komete
pag. 61



D821
Cestone Komete
pag. 62



D821-BIS
Cestone Komete con
posacenere



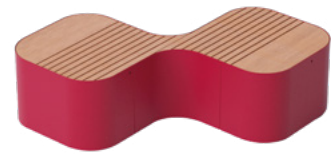

608-2M

Panca Pinch a 2 moduli per sole sedute.

pag. 70

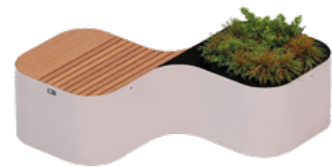

608-2M-F

Panca Pinch a 2 moduli con seduta e fioriera

pag. 71

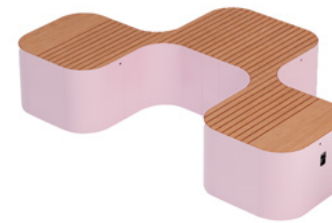

608-3M

Panca Pinch a 3 moduli per sole sedute

pag. 74



608-3M-F

Panca Pinch a 3 moduli con due sedute e fioriera

pag. 75

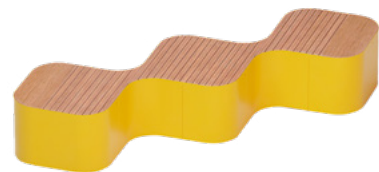

608-3ML

Panca Pinch a 3 moduli in linea per sole sedute

pag. 72

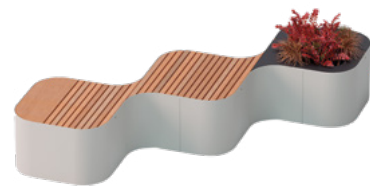

608-3ML-F

Panca Pinch a 3 moduli in linea con due sedute e fioriera

pag. 73



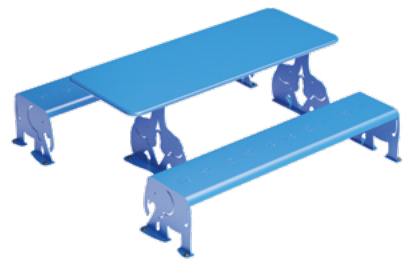

485
Tavolo da picnic Dumbo
pag. 88

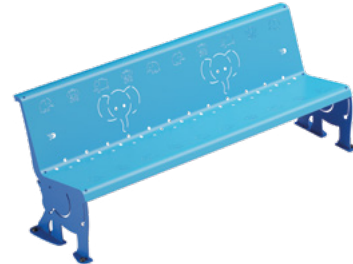

1138
Panchina Dumbo
pag. 89



1138-P
Panca Dumbo
pag. 89



D866-G
Giorgione il simpaticone
pag. 95



D866-T
Tito l'incuriosito
pag. 95



D866-M
Martina la timidina
pag. 95



1139
Panchina Kimba
pag. 87



1140
Panchina Boy



D832
Tavolo multiattività Loop
pag. 98



D866-P
Paolone il brontolone
pag. 95



D866-R
Renato lo sconcolato
pag. 95



D866-V
Vito l'impaurito
pag. 95

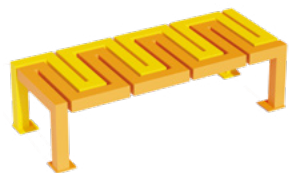

D833
Panca baby snake
pag. 86

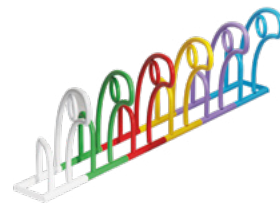

D858
Portabici Yoyo
pag. 103



D866-C
Cetta la felicetta
pag. 94



D867
Cestino Cest-It
pag. 100

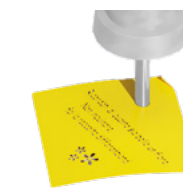

D867-P
Pannello Post-It
pag. 101



D868
Seduta S-It
pag. 102





D869
Librichina
pag. 84

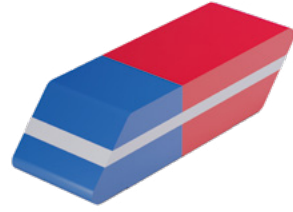

D870
Gommina la panchina
pag. 85



D871
Fiorozza
pag. 91



G552
Cestino Lauretta la
Ranetta
pag. 104



G553
Bruchetto composizione con Cestino, tre sedute e portabici
pag. 82

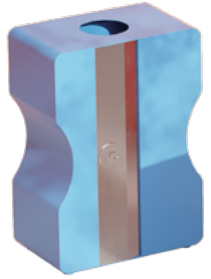

D872
Temperarifuti
pag. 107

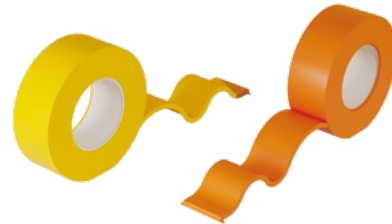

D873
Nastrina
pag. 97



D874
Fumettors
pag. 90



G556
Tubetto seduta con
fioriera
pag. 96

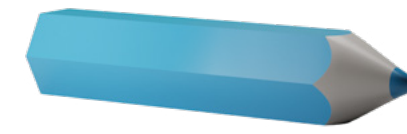

G557
Panca Matita
pag. 93



G560
Cestino Formaggino
pag. 106



G548
Cestino Nino il
Pesciolino
pag. 104



G549
Cestino Adelina la
Lumachina
pag. 104



G551
Cestino Mauro il
Dinosauro
pag. 104





231
Pensilina Acaya a sbalzo



231-BIS
Pensilina Acaya con pareti laterali
pag.114



256
Pensilina Gabry



277
Pensilina Anthea a sbalzo



277-BIS
Pensilina Anthea con pareti laterali



282
Pensilina Barocco



259
Pensilina Mini



261
Pensilina Scuolabus



263
Pensilina Romagna a sbalzo



306
Pensilina Liberty



311
Pensilina Modena p95



311-BIS
Pensilina Modena p165



263-BIS
Pensilina Romagna con pareti laterali



269
Pensilina Eclisse



273
Pensilina Genova



333
Pensilina Ciampino



333-SB
Pensilina Ciampino a sbalzo



368
Pensilina Space
pag.124





368-SB

Pensilina Space a sbalzo

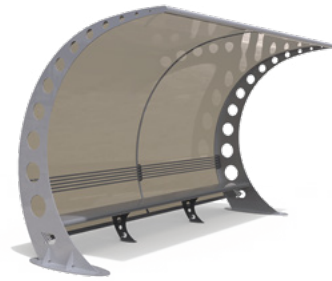

425

Pensilina Arkua



447

Pensilina Alessandra a sbalzo



604-PE-4-COMP1

Pensilina io 4 moduli

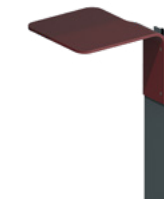

604-PE-0-T

Pensilina io optional tavolino



604-PE-0-V

Pensilina io optional parete laterale vetrata



447-BIS

Pensilina Alessandra con pareti laterali

pag.116



447W

Pensilina Alessandra Wood



448

Pensilina Carlotta



604-PE-0-PC

Pensilina io optional panca corta

pag.31



604-PE-0-PL

Pensilina io optional panca lunga

pag.31



606-PE-COMP1

Pensilina Noi

pag.40



448-BIS

Pensilina Carlotta autoportante

pag.118



604-PE-2-COMP1

Pensilina io 2 moduli



604-PE-3-COMP1

Pensilina io 3 moduli



606-PE-D-COMP1

Pensilina Noi doppia

pag.42



606-PE-0-P

Pensilina Noi optional panca



606-PE-0-V

Pensilina Noi optional parete laterale vetrata





D818
Pensilina Komete
pag.56



D818-B
Pensilina Komete con
bacheca



D863
Copertura auto Arles
pag.126



816
Pergola Living
pag.128



D818-S
Pensilina Komete Solar
pag.58



D818-S-B
Pensilina Komete Solar
con bacheca



G522
Pensilina Plaza
pag.120



D862
Aula didattica per esterno Young
pag.130



D864
Aula didattica per esterno Lucky con telo
ombreggiante



G524
Pensilina Robin
pag.122



G543
Pensilina PopUp



D855-P
Aula didattica per esterno Abacus con piastre
e telo ombreggiante



D855-BIS
Aula didattica per esterno Abacus da
interrare con telo ombreggiante





D855-P-PVC

Aula didattica per esterno Abacus con piastre e telo in PVC



D855-BIS-PVC

Aula didattica per esterno Abacus da interrare con telo in PVC



815

Tettoia Dynamo



436

Saletta fumatori Smoky



336

Tettoia auto Airone



268

Gazebo Morfeo

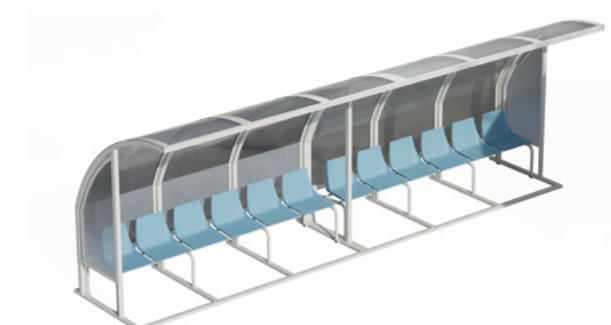

226-BIS-6

Pensilina San Siro



500

Impianto fotovoltaico



2002

Gazebo Belvedere



252

Copertura Oasi





157-2

Portabici Roma a due posti



157-3

Portabici Roma a tre posti



157-5

Portabici Roma a cinque posti



308-BIS

Portabici Pireo 9 posti



308-BIS-D

Portabici Pireo Display 9 posti



308-D

Portabici Pireo Display 5 posti



190

Portabici Ciclo Park
pag.155



236

Portabici Elix



236-D

Portabici Elix Display



354

Portabici Lucchetto

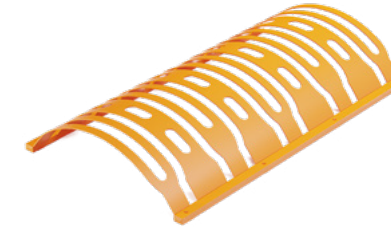

358

Portabici Flat



386

Portabici Milano
pag.146



286

Portabici verticale
Liberty
pag.144

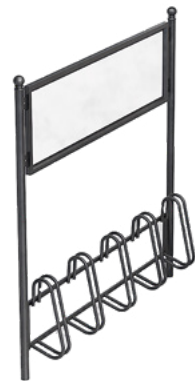

286-D

Portabici verticale
Liberty Display



308

Portabici Pireo 5 posti



386-BIS

Portabici Milano
bifacciale
pag.147



386-BIS-P

Portabici Milano
bifacciale con piastre



386-P

Portabici Milano con
piastre



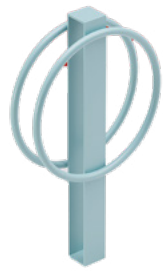



402
Portabici Ring



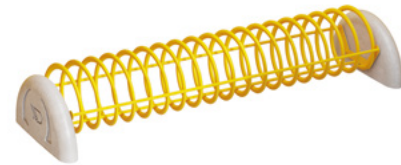

403
Portabici Hoop

414
Portabici Spiro
pag.152

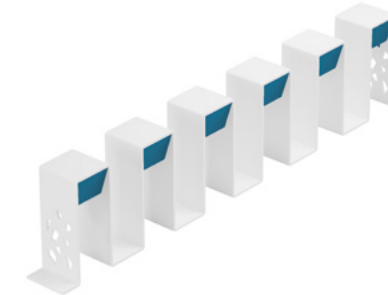

D824
Portabici Komete
pag.63

D825
Rastrelliera Komete
pag.63

D829
Portabici Snake

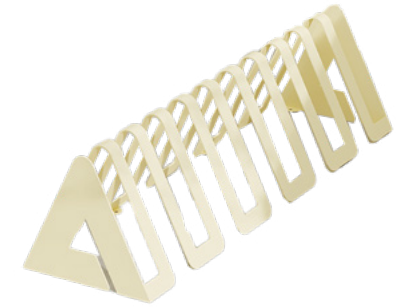

419
Portabici Giglio



605
Portabici Bucatino
pag.140



613
Portabici Elica
pag.142





D861
Bike box Komete



D878
Flo





D879
Plomb
pag.153



615
Portabici Rio con presa di ricarica
pag.143

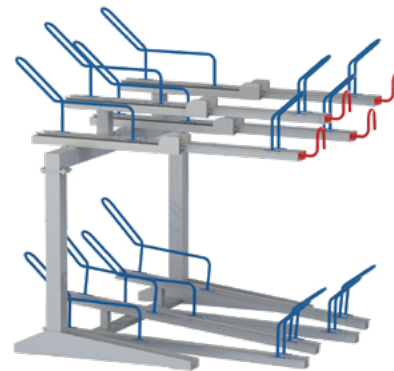

606-PO
Portabici Noi
pag. 47

911
Portabici Tandem modulo da 8 posti
pag.154



D881
Rastrelliera Eddy



D882
Rastrelliera per monopattini Speedy



G491
Rastrelliera Bel
pag.148





G494
Portabici Tatou
pag.151



G495
Portabici Rainbow

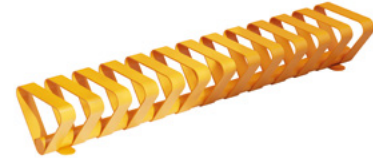

G496
Rastrelliera Tresette
pag.149

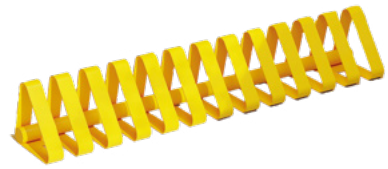

G496-BIS
Rastrelliera Tresette A



G513
Portabici Bean
pag.150



GENERALINDEX | **CICLOSTAZIONI**
BIKE STATIONS



810
Ciclostazione Maranello
pag.132



910
Ciclostazione DIMCAR



912-M
Colonnina Bike Service per manutenzione



912-R
Colonnina Bike Service per manutenzione e ricarica





298-A

Panchina Clematis
rainbow



298-BIS-V

Panchina Clematis
Seduta lato Convesso



pag.165



298-D-V

Panchina Clematis
dritta



pag.162



435-I

Panchina Luna
Inclusion



450

Panchina Debora



450-BIS-PI

Panchina Debora con
listoni in legno di pino
Nordico



298-R

Panchina Clematis
Ribbon



298-V

Panchina Clematis
Seduta lato Concavo



pag.164



334

Panchina Vera



450-I

Panchina Debora
Inclusion



450-R

Panchina Debora
Rainbow

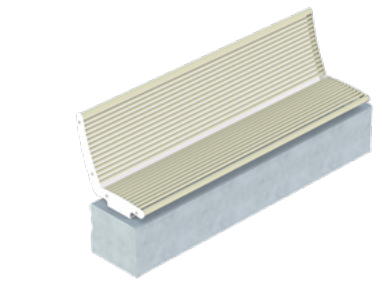

602

Seduta Panama con
schienale da muretto



369

Panchina Sydney



400-OK

Panchina Essenza



pag.172



435

Panchina Luna

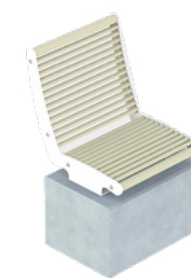

602-S

Seduta Panama singola
con schienale da
muretto



946

Panchina Liberty



947-v

Panchina Aurelia





950-P
Panchina Orchidea



1051
Panchina Dora



1052
Panchina Artemide



1121-BIS
Panchina Lesina con braccioli
pag.176



1125
Panchina Comfort



1127
Panchina Stylus



1052-I
Panchina Artemide Inclusion



1110
Panchina Madrid



1114
Panchina Antibes



1128
Panchina Margherita con listoni in legno



1128-BIS
Panchina Margherita



1130
Panchina Dubai



1116
Panchina Danaea



1118
Panchina Cervino



1121
Panchina Lesina



1131
Panchina Gabbiano



1133
Panchina Luxe in Acciaio inox
pag.173



1133-F
Panchina Luxe in Acciaio zincato



1134
Panchina Mira

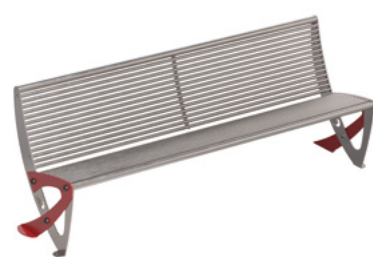

1136
Panchina Desy

1137
Panchina Teulada
pag.166 



G454
Panchina Ace
pag.170 



G461
Panchina Cross
pag.171 



G467
Panchina Eddie
pag.178 



1137-i
Panchina Teulada
Inclusion
pag.167 



1141
Panchina Delta



1141-i
Panchina Delta
Inclusion



G471
Panchina Record
pag.177 



G518
Panchina Flea con
fasce in Okumè



G519
Panchina Flea seduta
doppia con fasce in
Okumè
pag.174 



D819-BIS
Panchina Kometa



D830-BIS
Panchina Snake



D875
Panchina Colly



G532
Seduta singola Betty
con braccioli e fasce in
Okumè



G533
Seduta singola Betty
senza braccioli con
fasce in Okumè



G534
Panchina Betty con
braccioli e fasce in
Okumè
pag.168 



G535
Panchina Betty senza braccioli con fasce in Okumè
pag.169



G545
Seduta Portland con schienale
pag.179



401-OK
Panca Essenza
pag.183



417
Panca Giglio



451
Panca Iccos
pag.184



GENERALINDEX | **PANCHE SEATINGS**



238-P
Panca Dalia



297
Panca Siris
pag.182



334-P
Panca Vera



484-P-OK
Panca Round con listoni in legno di Okumè



486-P
Panca Clematis
pag.183

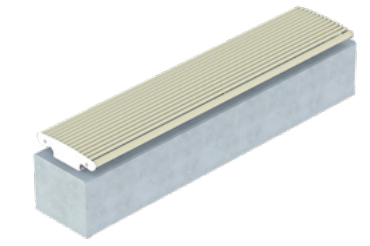

602-P
Seduta Panama da muretto



355
Panca Quadrio



356
Rubix
pag.185



357
Panca Desk

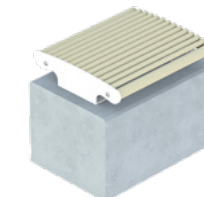

602-P-S
Seduta Panama singola da muretto



603
Panca Hello
pag.180



604-PA
Panca io
pag.31





606-M

Seduta Noi
pag.45



606-M-R

Seduta Noi con
rastrelliera
pag.46



606-M-S

Seduta Noi con
schienale e ricarica
USB
pag.45



608-3ML

Panca Pinch a 3 moduli
in linea per sole sedute
pag.72

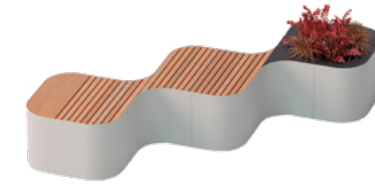

608-3ML-F

Panca Pinch a 3 moduli
in linea con due sedute
e fioriera
pag.73



952

Panca Orchidea



606-M-SF

Seduta Noi con fioriera
pag.46

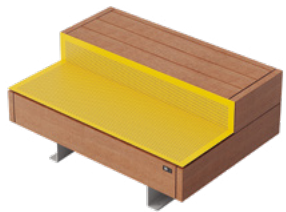

606-M-SL

Seduta Noi con
schienale
pag.45

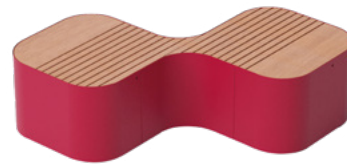

608-2M

Panca Pinch a 2 moduli
per sole sedute.
pag.70



1113

Panca Genius



1114-P

Panca Antibes



1116-P

Panca Danea

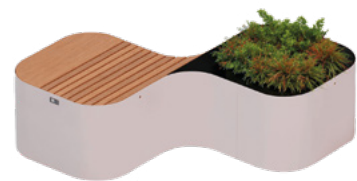

608-2M-F

Panca Pinch a 2 moduli
con seduta e fioriera
pag.71

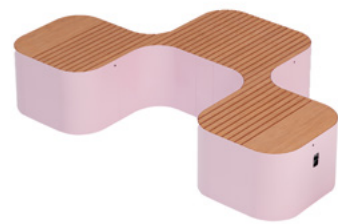

608-3M

Panca Pinch a 3 moduli
per sole sedute
pag.74



608-3M-F

Panca Pinch a 3 moduli
con due sedute e
fioriera
pag.75



1121-P

Panca Lesina



1135

Panca Osiria



1135-BIS

Panca Osiria con listoni
in legno





1137-P
Panca Teulada



1141-P
Panca Delta



D813
Panca Thin
pag.189



G462
Seduta Cubik con listoni in legno



G462-BIS
Seduta Cubik con piano in metallo



G546
Panca D'attesa Portland



D814
Panca curva Thin
pag.188



D819
Panca Komete





D830
Panca Snake



D877
Simply Seduta In Polystone

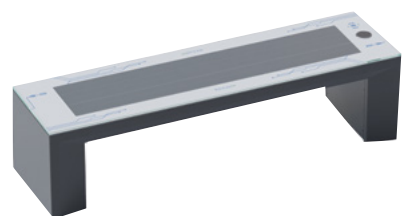

D877-L
Simply Seduta In Lamiera

D883
Panca Rays smart
pag.186



G470
Panca Ondina
pag.187



G517
Panca Flea seduta doppia con fasce in Okumè





200

Cestone Virgo



200-BIS

Cestone Virgo con
coperchio apribile



pag. 219



218

Cestone Elmo



pag. 211



359

Cestone Heron



360

Cestone Paint Black



361

Cestone Oblò



218-BIS

Cestone Elmo con
posacenere



pag. 211



228

Cestone Mida



228-BIS

Cestone Mida con
coperchio e posacenere



pag. 218



371

Cestone Demos



398

Cestone Tower



pag. 207



416

Cestone Giglio



243-BIS

Cestone Sassari con
coperchio



291

Cestone Barocco



293

Cestone Liberty



438

Cestone Klar



pag. 210



441

Cestone Scudo



452-BIS

Cestone Phuro One



pag. 207



606-CE
Cestone Noi
pag. 48



812
Cestone Maori



D821
Cestone Komete
pag. 62



G473-BIS
Cestone Ziggy con
coperchio e posacenere
pag. 206



G490
Cestone Cubik
pag. 200



G490-BIS
Cestone Cubik con
coperchio
pag. 200



D821-BIS
Cestone Komete con
posacenere



D827
Cestone Snake



D827-BIS
Cestone Snake con
coperchio e posacenere



G514
Cestone Bob





G514-BIS
Cestone Bob con
coperchio



G515
Cestone Bob con
posacenere
pag. 209

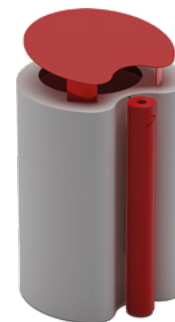

G455
Cestone Alvarian
pag. 208

G455-BIS
Cestone Alvarian con
coperchio
pag. 208



G473
Cestone Ziggy
pag. 206



G515-BIS
Cestone Bob con
coperchio e posacenere
pag. 209



G521
Cestone Harry



G521-BIS
Cestone Harry con
coperchio
pag. 201





G538

Cestone PopUp

pag. 202



208-BIS

Cestino Taormina con
coperchio



208-BIS-P

Cestino Taormina con
coperchio e posacenere



pag. 213



216

Cestino Ostuni



GENERALINDEX

CESTINI PORTARIFIUTI DA ESTERNO
OUTDOOR LITTER BINS



219

Cestino Capri



235

Cestino Alghero



241

Cestino Palau



203

Cestino Pirro

pag. 217



205

Cestino Rudiae



208

Cestino Taormina



290

Cestino Barocco



290-BIS

Cestino Barocco con
coperchio



292

Cestino Liberty





292-BIS
Cestino Liberty con coperchio
pag. 215



312
Cestino Mida



312-BIS
Cestino Mida con coperchio
pag. 216



350-BIS
Cestino Alfere con coperchio
pag. 214



364
Cestino Flex



383
Cestino Forli con coperchio e posacenere



317
Cestino Boing



318
Cestino Aladino



318-BIS
Cestino Aladino con coperchio



389
Cestino ecoBIO con coperchio e posacenere



399
Cestino Ellipso
pag. 212



415
Cestino Giglio



331
Cestino Urano con coperchio e posacenere



349
Cestino Condor



350
Cestino Alfere



604-CO-L
Cestino lo con rivestimento in legno
pag. 33



604-CO-M
Cestino lo con rivestimento in metallo
pag. 33



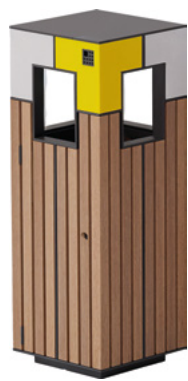

607-CO-L
Cestino Target in legno
pag. 199

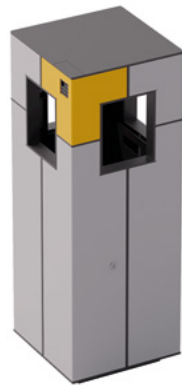

607-CO-M
Cestino Target in metallo
pag. 198



G502
Cestino Diapason antiterrorismo
pag. 204



G502-BIS
Cestino Diapason antiterrorismo con coperchio
pag. 204



G503
Cestino Diapason
pag. 205



D822
Cestino Komete
pag. 62



D822-BIS
Cestino Komete con coperchio e posacenere



D826
Cestino Snake



G504
Cestino Diapason con coperchio
pag. 205



G505
Cestino Diapason attacco a palo



G505-BIS
Cestino Diapason attacco a palo e coperchio



D826-BIS
Cestino Snake con coperchio



G469
Cestino Miss Thin
pag. 203



G469-BIS
Cestino Miss Thin con coperchio
pag. 203



G506
Cestino Diapason attacco a muro



G506-BIS
Cestino Diapason attacco a muro con coperchio



G537
Cestino PopUp
pag. 202





293-BIS
Cestone Liberty maxi



360-BIS
Cestone Paint
pag. 235



377
Cestone Elios



442
Cestone Riclè



452
Cestone Phuro



G456
Cestone Benjamin
pag. 225



377-BIS
Cestone Elios con coperchio



377-BIS-CLS
Cestone Elios con coperchio e basamento in CLS
pag. 232



377-CLS
Cestone Elios con basamento in CLS



G456-BIS
Cestone Benjamin con coperchio



G492
Cestone Kurt Three
pag. 226



G492-BIS
Cestone Kurt Three con coperchio
pag. 226



440
Cestone Geo
pag. 233



433
Cestone Clean Maxi



434
Cestone HEX
pag. 234



G493
Cestone Kurt four
pag. 227



G493-BIS
Cestone Kurt four con coperchio
pag. 227



G525
Cestone Sam
pag. 228





203-D
Cestino Doppio Pirro



203-Q
Cestino Quadruplo Pirro



203-T
Cestino triplo Pirro
pag. 231



376
Cestino Trio con posacenere



412-F
Cestino Ecocity per raccolta farmaci



412-P
Cestino Ecocity per raccolta pile esauste



241-Q
Cestino Quadruplo Palau



312-BIS-T
Cestino Triplo Mida con coperchio e posacenere
pag. 229



325
Clean Dog Kit



412-TF
Cestino Ecocity per raccolta TF



423
Cestino Ekos
pag. 231



501
Cestino Glifo



326
Cestino Clean



326-M
Cestino Clean con fissaggio a muro



347
Contenitore Fido



G460
Cestino Tobia
pag. 237



G507
Cestino Diapason tris antiterrorismo
pag. 230



G507-BIS
Cestino Diapason tris antiterrorismo con coperchio





G508

Cestino Diapason tris
pag. 230



G509

Cestino Diapason tris
con coperchio



GENERALINDEX | POSACENERE
OUTDOOR ASHTRAYS



193

Portamozziconi Simple



193-BIS

Portamozziconi Simple
da interrare



202

Posaceneri Smoke



237

Posaceneri Cicco
con attacco su palo
esistente



237-BIS

Posaceneri Cicco con
colonnino



237M

Posaceneri Cicco con
attacco a muro



246

Posaceneri Spira



247

Posaceneri Arkea



248

Posaceneri Olympic



pag. 244

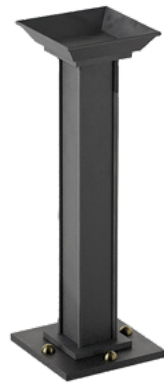

249
Posacenere Imperiale

250
Posacenere Eliseo



367
Posacenere Fumino
pag. 245



409
Posacenere Barocco



410
Posacenere Liberty
pag. 244





411
Posacenere Cenerino
con coperchio e attacco
su palo esistente



373
Posacenere Smokers



374
Posacenere Fumy



375
Posacenere Fum-Off



411-BIS
Posacenere Cenerino
con coperchio e
colonnino



411M
Posacenere Cenerino
con coperchio e attacco
a muro



424
Posacenere Twister a
muro



zzz



408
Posacenere Cenerino
con attacco su palo
esistente



408-BIS
Posacenere Cenerino
con colonnino



408M
Posacenere Cenerino
con attacco a muro
pag. 245



424-BIS
Posacenere Twister su
palo



431
Posacenere Bond



D823
Posacenere Komete





G480
Posacenere Charlie
pag. 243



G530
Posacenere ZigoZago
pag. 242



486
Tavolo da picnic
Clematis

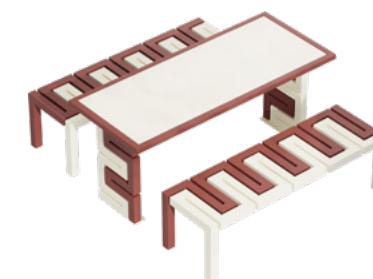

D831
Tavolo da picnic Snake
pag. 259



G497
Tavolo da picnic
Weekend
pag. 253



G498
Tavolo da picnic
Holyday
pag. 253



G488
Tavolino Cubik con
piano in legno di
okumè



G488-BIS
Tavolino Cubik con
piano in metallo



GENERALINDEX | TAVOLI DA PICNIC
PICNIC TABLES



482
Tavolo da picnic Break
pag. 254



483-OK
Tavolo da picnic
Essenza
pag. 255



484-OK
Tavolo da picnic Round
pag. 258



D876
Tavolo per esterno
Simply con piano in
Polystone



D876-L
Tavolo per esterno
Simply con piano in
metallo





198
Fioriera Azalea



198-BIS
Fioriera Azalea con
panca circolare



238
Fioriera Dalia





382
Fioriera Camelia



418
Fioriera Giglio



439
Fioriera Ozan
pag. 270



244
Fioriera Versilia



244-BIS
Fioriera Versilia con
panca circolare





298GB
Clematis Grand
Bouquet
pag. 266



604-FIO-090
Fioriera io da cm.
90x50
pag. 32



604-FIO-110
Fioriera io da cm.
110x50
pag. 32



604-FIO-135
Fioriera io da cm.
135x50
pag. 32



355-F
Fioriera Quadrio





379
Fioriera Ermes
pag. 270





381
Fioriera Alba

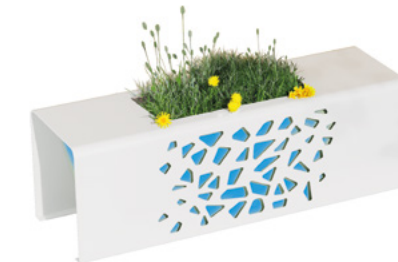

606-M-F
Fioriera Noi
pag. 46

D820
Fioriera Komete





950

Fioriera Orchidea Maxi



950-BIS

Fioriera Orchidea Midi



950-R

Fioriera Orchidea Maxi
con pareti in lamiera
forata



pag. 268



D839V

Fioriera Rusty in
acciaio verniciato



G465

Fioriera Flora alta



pag. 273



G465-BIS

Fioriera Flora bassa



pag. 273



950-BIS-R

Fioriera Orchidea Midi
con pareti in lamiera
forata



953

Fioriera Orchidea Midi
Rettangolare



954

Fioriera Orchidea Maxi
Rettangolare



G466

Fioriera Flora Big con
seduta



pag. 265



G489

Fioriera Cubik Alta



G489-BIS

Fioriera Cubik bassa



pag. 275



974

Fioriera Tulipano



pag. 271



D828

Fioriera Snake



D839C

Fioriera Rusty in
acciaio Corten



pag. 274



G516

Fioriera Flea con fasce
in Okumè



pag. 272



G520

Fioriera Harry



pag. 275



338
Griglia Dafne
pag. 284

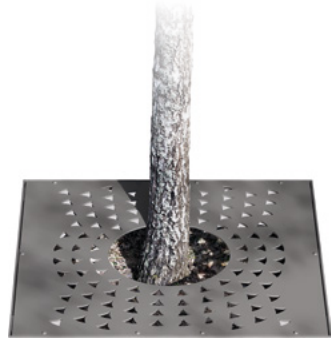

339
Griglia Millefoglie
pag. 285



340
Griglia Primula
pag. 286



341
Salvapianta Anemone
pag. 282



342
Salvapianta Genziana
pag. 281



343
Salvapianta
Biancospino
pag. 283

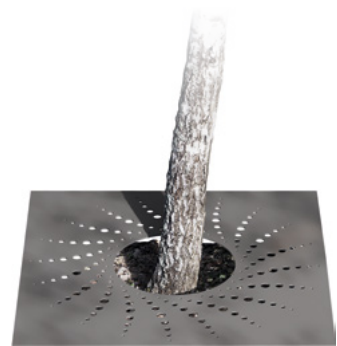

G526
Griglia Scirocco
pag. 288

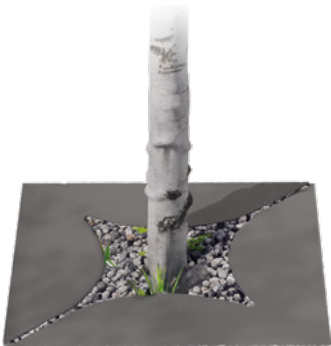

G527
Griglia Star
pag. 289



300
Transenna parapedone
Walk
pag. 302

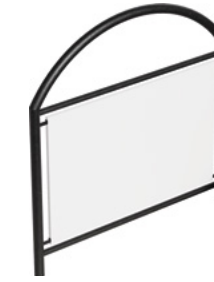

300-BIS
Transenna City
pag. 302



301
Transenna Flora



302
Transenna Tea



351
Recinzione Palermo ad
Archi
pag. 303



352
Recinzione Palermo
Pubblicitaria
pag. 303



353
Recinzione Imperia

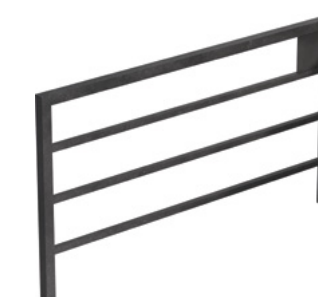

405
Transenna Simply
pag. 304



405-BIS
Transenna Simply
pubblicitaria
pag. 305



610
Parapedone Zen
pag. 299



611-L
Parapedone UpsideDown con base larga
pag. 298



611-S
Parapedone UpsideDown con base stretta
pag. 298



956-DX
Parapedone Open&Go con transenna destra da cm.120



956-SX
Parapedone Open&Go con transenna sinistra da cm.120



612
Parapedone Tau
pag. 296



614-A
Parapedone Ciak ADV
pag. 300



614-G
Parapedone Ciak grid
pag. 300



614-L
Parapedone Ciak legno
pag. 300



955-DX
Parapedone Open&Go con transenna destra da cm.90
pag. 301



955-SX
Parapedone Open&Go con transenna sinistra da cm.90
pag. 301





195
Dissuasore Teseo





195-BIS
Dissuasore Teseo con anelli



227
Dissuasore Icaro
pag. 314





395
Dissuasore Torpedo



396
Dissuasore Roller
pag. 315



601
Dissuasore Pin
pag. 317





227-BIS
Dissuasore Icaro con anelli
pag. 314





232
Dissuasore Stilo
pag. 315

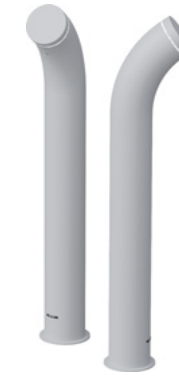

253
Dissuasore Doria

609
Dissuasore Bow
pag. 310



612-D
Dissuasore Tau
pag. 313



G478
Dissuasore Stanley
pag. 316



253-BIS
Dissuasore Doria con anelli



262
Dissuasore Archetto



332
Dissuasore salva posto auto



G479
Dissuasore Oliver
pag. 316





176

Tabella Santiago per
descrizioni fisse



176-BIS

Tabella Santiago
per descrizioni
Intercambiabili



184

Tabellone Informativo
pag. 327



215

Tabellone Visual
pag. 329



254

Leggio Barocco
pag. 325



257

Orologio Clessidra



185

Totem Quadrato



187

Totem Triangolare



188

Tabella Messapia per
targhe in ceramica



258

Orologio Epoca



271

Tabella Attendi
Autobus



275

Bacheca Classic



191

Leggio Archè
pag. 324



192

Bacheca Prestige



196

Tabellone Gotico

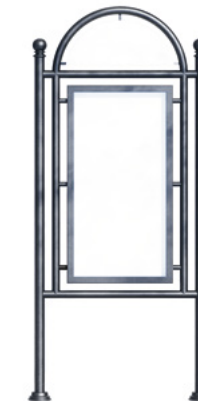

276

Bacheca Athena
pag. 328



280

Tabellone Barocco



281

Leggio Sinuo
pag. 324





299
Tabella Minerva



309
Tabellone Maxi 6x3
Monofacciale



309-BIS
Tabellone Maxi 6x3
Bifacciale



420
Leggio Giglio



426
Bacheca Eliade



446
Tabella Temporary
pag. 326



320
Tabella Flag





365
Totem Display



366
Bacheca Vista



D860
Lettera Alfy 3D



G459
Totem Phil
pag. 323



G529
Totem YouAreHere
pag. 322





378
Tabella Porta orari
Linea 46



390
Tabella porta orari
Modena Double



391
Tabella porta orari
Modena Inox



G536
Totem PopUp
pag. 323



G539
Bacheca PopUp a terra
bifacciale cm100x140h



G541
Bacheca PopUp a
terra bifacciale con
anta apribile da
cm140x200h





G541-BIS

Bacheca PopUp a terra
bifacciale a giorno
cm140x200h



D859

Fontana You&Me

pag. 333



Colori / Colors

Bucciato / Peeled



Liscio opaco / Opaque



Liscio semilucido / Semi-glossy

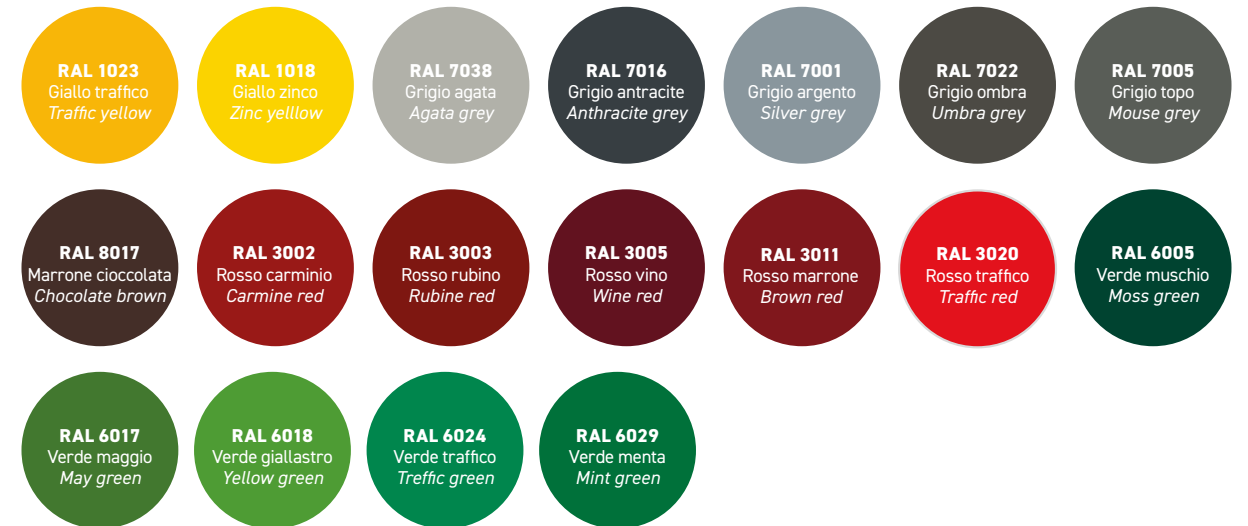
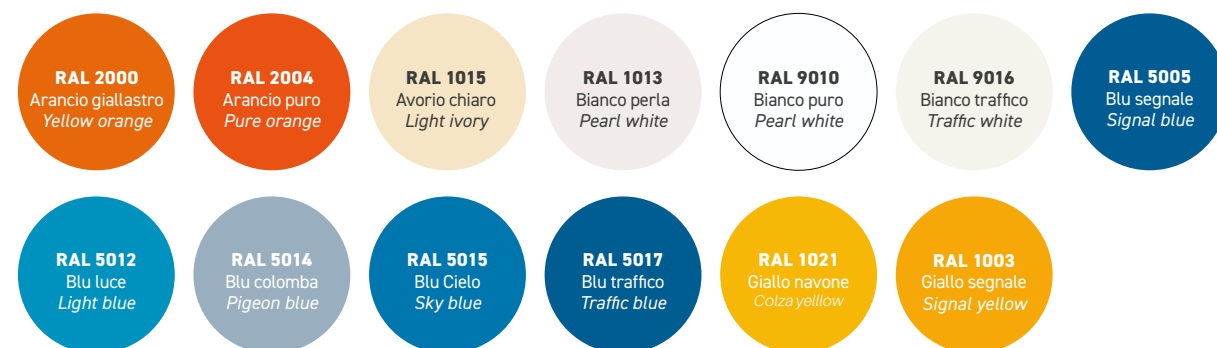

Raggrinzato / Wrinkled



Speciali / Special



Lucido / Glossy





MATERIALS ACCIAIO

STEEL

As for the design of our products, behind every piece of street furniture there is a story, that of its materials and colors.

Our materials and colors undergo careful selection and testing, and we treat them in a way that is both economical and ecological. The base material of most of our products is steel and it is always protected from galvanizing.

PRE-TREATMENT

Before painting, the product undergoes a spray wash with special degreasing liquids. After washing it, the product is dried in a drying oven for 15 minutes before being painted

ANTI-CORROSION TREATMENT

In order to give adequate protection against atmospheric agents, the product is subjected to a first coating cycle using an anti-corrosion base in thermosetting powder based on epoxy resins with special pigments.

The anti-corrosive polymerization occurs at this stage.

FIRST BAKING (ANTI-CORROSION)

The product treated with the anti-corrosion primer is baked in an oven for 15 minutes at 180°C. In this phase, the anti-corrosion layer polymerizes.

PAINTING

The product undergoes a final painting cycle with a powder coating made from polyester resins. The painting is done using electrostatic spray equipment, which allows the powder to deposit evenly on the pieces.

FINAL BAKING

The painted product is then subjected to a final baking process for 20 minutes at 160°C.

Come per il design, ogni nostro prodotto nasconde una storia, quella dei suoi materiali e colori. Selezioniamo accuratamente e collaudiamo con attenzione i nostri materiali e colori che trattiamo in modo economico ed ecologico. L'acciaio è il materiale di base per la maggior parte dei nostri prodotti ed è sempre protetto dalla zincatura.

PRE-TRATTAMENTO

Prima di essere verniciato, il manufatto, viene pre-trattato mediante un lavaggio a spruzzo con speciali liquidi sgrassanti.

Dopo il lavaggio, il manufatto da verniciare, viene asciugato per 15 minuti in essiccatoio.

TRATTAMENTO ANTICORROSIVO

Al fine di conferire idonea protezione contro gli agenti atmosferici, il manufatto è sottoposto ad un primo ciclo di verniciatura utilizzando un fondo anticorrosivo in polvere termoidurente a base di resine epossidiche con speciali pigmenti.

PRIMA COTTURA (ANTICORROSIVO)

Il manufatto trattato con il fondo anticorrosivo è sottoposto ad una prima cottura al forno della durata di 15 minuti alla temperatura di 180°.

In questa fase l'anticorrosivo polimerizza.

VERNICIATURA

Il manufatto è sottoposto ad un ciclo finale di verniciatura con polvere termoidurente a base di resine poliesteri. La verniciatura è eseguita con apparecchiature a spruzzo elettrostatico, che consentono alla polvere di depositarsi uniformemente sui pezzi.

COTTURA FINALE

Il manufatto verniciato è sottoposto ad una cottura finale al forno della durata di 20 minuti alla temperatura di 160°.



MATERIALS LEGNO

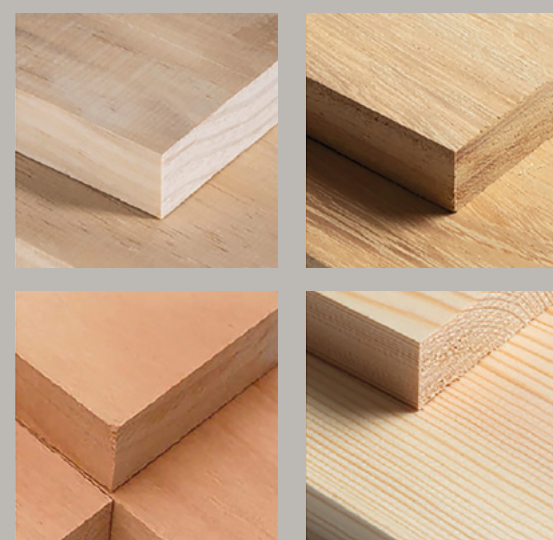

Okumè, Pino nordico ed Iroko, queste varietà di legno duro vengono fornite con trattamento di finitura pigmentato a base d'acqua, su richiesta del cliente il legno può essere lasciato naturale. Su richiesta, il legno duro, è disponibile anche con certificazione FSC.

Dimcar® si riserva di selezionare di volta in volta i legni duri più adatti alle esigenze di prodotto e/o progetto e/o secondo le disponibilità del mercato. Il legno è un materiale naturale e, in quanto tale, è fisiologico che vari aspetto nel tempo soprattutto a seconda della tipologia di legno e/o delle caratteristiche ambientali del luogo, una adeguata e frequente manutenzione aiuta a preservarne la qualità rallentando il fisiologico processo di invecchiamento.

WOOD

Okoumé, Nordic Pine and Iroko are hardwood varieties provided with a water-based pigmented finish. Upon request, the wood can be left natural. Additionally, the hardwood is available with FSC certification upon request. Dimcar® reserves the right to select the most suitable hardwoods for each product or project, depending on market availability. Wood is a natural material, and as such, it is normal for its appearance to change over time, especially depending on the type of wood and the environmental characteristics of the location. Proper and regular maintenance helps preserve its quality, slowing down the natural aging process.

MATERIALS POLICARBONATO

POLYCARBONATE

Polycarbonate is distinguished by its high resistance to impacts and UV rays, even after many years of exposure to atmospheric agents.

Its great flexibility allows it to be used on curved, even complex, surfaces, shaped using hot or cold forming technology without compromising its structural capabilities. It is suitable for the creation of integral structures such as arches or tunnels with a curvature radius of up to 150 times the thickness of the sheet.

Weighing over 50% less than glass sheets, it simultaneously ensures resistance to hail impacts and accidental shocks, even after prolonged sun exposure. This complies with safety standards regarding translucent glazing in public and work environments.

Compact polycarbonate and cellular polycarbonate are both thermoplastic materials derived from polycarbonate and are used in the creation of design elements.

Compact polycarbonate is better suited for applications requiring high transparency and mechanical strength, while cellular polycarbonate is more suitable for applications requiring thermal and acoustic insulation and reduced weight.

Il policarbonato si contraddistingue per l'elevata resistenza agli urti e dai raggi U.V. , anche dopo molti anni di esposizione agli agenti atmosferici.

La grande flessibilità ne consente l'utilizzo su superfici curve, anche complesse, piegate con tecnologia di formatura a caldo o a freddo senza venir meno alle proprie capacità strutturali, prestandosi alla realizzazione di strutture integrali ad arco o tunnel sino ad un raggio di curvatura pari a 150 volte lo spessore della lastra.

Il peso, inferiore di oltre il 50% rispetto alle lastre in vetro, assicurano al contempo una resistenza all'impatto della grandine ed agli urti accidentali anche dopo una lunga esposizione al sole rispondendo così alle normative di sicurezza riguardo alle vetrate traslucide negli ambienti pubblici e di lavoro.

Il policarbonato compatto e il policarbonato alveolare sono entrambi materiali termoplastici derivati dal policarbonato ed entrambi sono utilizzati per la realizzazione di elementi di design.

Il policarbonato compatto è più adatto per le applicazioni in cui è richiesta una elevata trasparenza e resistenza meccanica, mentre il policarbonato alveolare è più adatto per le applicazioni in cui è richiesto un isolamento termico e acustico e un peso ridotto.

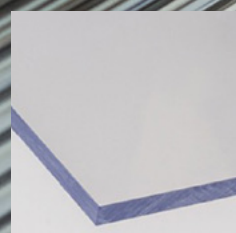

Compatto trasparente

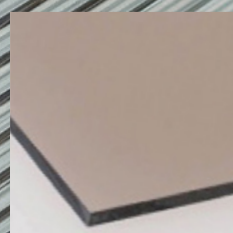

Compatto fumè

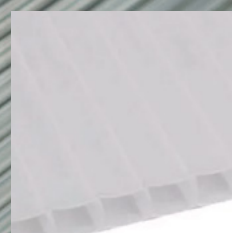

Alveolare opaco



Alveolare trasparente

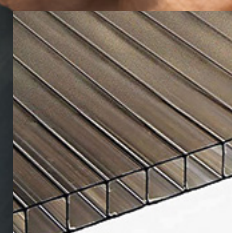

Alveolare fumè



MATERIALS VETRO

GLASS

Laminated safety glass, resulting from the assembly of two sheets using a PVB (polyvinyl butyral) interlayer.

The intermediate layer keeps the two glass sheets in place even when the glass breaks. Thanks to its strength, it prevents the formation of large, sharp fragments, remaining compact even when fractured.

The PVB layer also enhances the material's sound insulation properties and increases protection against ultraviolet rays.

Vetro stratificato di sicurezza quale risultato dell'assemblaggio di due lastre mediante un intercalare in PVB (polivinilbutirrale).

Lo strato intermedio mantiene le due lastre di vetro in posizione anche quando quest'ultimo si rompe, e con la sua resistenza impedisce la formazione di larghi frammenti affilati mantenendosi compatto anche se fratturato.

Lo strato di PVB conferisce al materiale anche un maggiore effetto di isolamento acustico ed accresce la protezione contro i raggi ultravioletti.



Vetro stratificato

OGNI GIORNO LE NOSTRE
MANI PLASMANO IL METALLO,
DIALOGANO CON LUI,
SVELANDOGLI CIÒ CHE PUÒ
DIVENTARE.

*OUR HANDS SHAPE AND COMMUNICATE
WITH THE METAL DAILY, REVEALING
ITS POTENTIAL.*





DIMCAR
City Life Design

Dimcar s.r.l.

Via Taurisano 101, Z.A.
73059 Ugento (LE) ITALY
Tel. 0833.955013 - 0833.955088
Numero Verde 800.677.233
Fax 0833.555481
info@dimcar.it

**SERVIZIO CLIENTI
DALL'ORDINE
ALL'ASSISTENZA**

E-MAIL

Front office:	info@dimcar.it
Preventivi:	preventivi@dimcar.it / commerciale@dimcar.it
Ordini:	ordini@dimcar.it
Produzione:	produzione@dimcar.it
Logistica:	spedizioni@dimcar.it
Amministrazione:	amministrazione@dimcar.it
Acquisti:	acquisti@dimcar.it
Assistenza tecnica:	assistenza@dimcar.it
Eventi:	eventi@dimcar.it



DIMCAR SRL

Via Taurisano Z.A. n.101
73059 Ugento (LE) ITALY

T. +39 0833.955013

T. +39 0833.955088

Numero Verde 800.677.233

info@dimcar.it

DIMCAR.IT

